

State of Florida  
Department of Transportation  
Procurement Office  
605 Suwannee Street, MS 20  
Tallahassee, Florida 32399-0450

**INVITATION TO BID REGISTRATION**

\*\*\*\*\*

**PLEASE COMPLETE AND RETURN THIS FORM ASAP**

**E-MAIL TO** Katie Wagner [katie.wagner@dot.state.fl.us](mailto:katie.wagner@dot.state.fl.us)

\*\*\*\*\*

Bid Number: ITB-DOT-17/18-9106-KW

Title: ALUMINUM MATERIALS

Bid Due Date & Time (On or Before): June 28, 2018 @ 3:00 P.M. Local Time

Potential bidders should notify our office by returning this Bid Registration Form as soon as possible after downloading. Complete the information below and fax this sheet only to the Florida Department of Transportation Procurement Office at Katie Wagner [katie.wagner@dot.state.fl.us](mailto:katie.wagner@dot.state.fl.us)

**THE INVITATION TO BID DOCUMENT YOU RECEIVED IS SUBJECT TO CHANGE. Notice of changes (Addenda), will be posted on the Florida Vendor Bid System at [www.myflorida.com](http://www.myflorida.com) , under this bid number (click on “BUSINESS”, click on “Doing Business with the State”, under “Everything for Vendors and Customers”, click on “Vendor Bid System (VBS)”, then click on “Search Advertisements”, click on the drop-down arrow beside the box under Advertisement Type, select Competitive Solicitation, click on the drop-down arrow beside the box under Agency, select DEPARTMENT OF TRANSPORTATION, then go to the bottom of the same page and click on Advertisement Search. It is the responsibility of all potential bidders to monitor this site for any changing information prior to submitting your bid.**

Company Name: \_\_\_\_\_

Address: \_\_\_\_\_

City, State, Zip: \_\_\_\_\_

Telephone: ( ) \_\_\_\_\_ Fax Number: ( ) \_\_\_\_\_

Contact Person: \_\_\_\_\_

Internet E-Mail Address: \_\_\_\_\_

For further information on this process, e-mail or telephone:  
Katie Wagner, Procurement Agent  
[Katie.wagner@dot.state.fl.us](mailto:Katie.wagner@dot.state.fl.us)  
(850)-414-4956

BID PAGES

BID #: ITB-DOT-17/18-9106-KW

BID TITLE: ALUMINUM MATERIALS

The following aluminum materials shall be of the appropriate alloy for the point of delivery and meet all applicable "DOT" specifications and requirements.

The Offeror shall insert the Unit Price for the item set forth in the table.

**Delivery must be made within thirty (30) calendar days or less upon receipt of a purchase order by the contract vendor at their designated ordering location. If more time is needed, the bidder should state the extra time required and the reasons why, in their response. Acceptance will be subject to the Department's approval – orders (30) calendar days or older maybe subject to the Department's denial or order.**

**DMS COMMODITY #30101500**

Must be included with ALL bids: "In-State Preference Form".

**In-State Preference:** Based on registration with the Department of State, if you are considered an out of state vendor you must Include a written opinion of the attorney licensed to practice law in that foreign state.

**ANGLES**

**OVIEDO, FL**

"DOT" NUMBER	DESCRIPTION	ESTIMATED QUANTITY EACH	LBS LF	UNIT PRICE	TOTAL	
705-040	1" x 1" x .1875 x 25' <b>Alloy 6063-T52</b>	11	.401			Effective September 10, 2018
705-060	1.5" x 1.5" x .125" x 25' <b>Alloy 6063-T52</b>	9	.422			Effective September 10, 2018
705-070	2" x 3" x .1875" x 25' <b>Alloy 6061-T6</b>	21	1.071			Effective Immediately
705-080	2" x 2" x .25" x 25' <b>Alloy 6063-T52</b>	27	1.125			Effective September 10, 2018
705-090	1" x 1" x .125" x 25' <b>Alloy 6063-T52</b>	7	.276			Effective September 10, 2018
705-100	1.25" x 1.25" x .1875" x 25' <b>Alloy 6063-T52</b>	6	.511			Effective September 10, 2018

## CHANNELS

## OVIEDO, FL

"DOT" NUMBER	DESCRIPTION	ESTIMATED QUANTITY EACH	LBS LF	UNIT PRICE	TOTAL	
706-020	1.5" x .5" x .125" x 20', Sharp Corners, <b>Alloy 6063-T52 *</b>	5	.327			Effective Immediately
706-030	2" x .5" x .125" x 20' <b>Alloy 6063-T52 *</b>	10	.551			Effective Immediately
706-040	1.5" x .625" x .125" x 20' Square corner <b>Alloy 6063-T52 *</b>	5	.375			Effective Immediately
706-050	1" x 1" x .125" x 20' Square corner <b>Alloy 6063-T52 *</b>	10	.431			Effective Immediately
706-060	1.5" x 1.5" x .125" x 20' Square corner <b>Alloy 6063-T52 *</b>	5	.637			Effective Immediately
706-070	2" x 1" x .125" x 20' Square Corners <b>Alloy 6063-T52 *</b>	25	.564			Effective Immediately
706-071	2" x 1.250" x 25' <b>Alloy 6061</b>	10	1.071			Effective September 10, 2018
706-072	2" x 2" x 1/8" x 20' <b>Alloy 6061</b>	10	.845			Effective Immediately
706-075	2" x 1" x .1875" x 25' <b>Alloy 6061-T6</b>	10	.551			Effective Immediately
706-080	2.5" x 1.50" x .125" x 20' <b>Alloy 6061-T6</b>	20	.764			Effective Immediately
706-090	2.5" x .625" x .1875" x 20' <b>Alloy 6061-T6</b>	10	.625			Effective Immediately
706-100	3" x .1875" x 30' Square Corners <b>Alloy 6063-T52</b>	20	1.250			Effective Immediately
706-105	3" x 1.5" x .25" x 30' Sharp Corners <b>Alloy 6063-T52</b>	40	1.730			Effective September 10, 2018
706-130	4" x 1.647" x .247" x 30' <b>Alloy 6061-T6</b>	20	2.160			Effective Immediately
706-150	6" x 1.920" x .200" x 25' <b>Alloy 6061-T6</b>	2	2.128			Effective Immediately
706-165	7" x 2.110" x .230" x 25' <b>Alloy 6061-T6</b>	5	3.541			Effective Immediately

\*Substitute alloy (6063-T2, 6063-T52, 6061-T6, 3003, 5052-H32, 6063, 6061-T6ss) as stated in description

**BARS****OVIEDO, FL**

"DOT" NUMBER	DESCRIPTION	ESTIMATED QUANTITY EACH	LBS LF	UNIT PRICE	TOTAL	
707-015	1.25" x .25" x 12' <b>Alloy 6061-T6</b>	20	.368			Effective Immediately
707-020	1.5" x .25" x 12' <b>Alloy 6061-T6</b>	20	.441			Effective Immediately
707-060	2" x .25" x 12' <b>Alloy 6061-T6</b>	1	.588			Effective Immediately
707-070	2.5" x .1875" x 12' <b>Alloy 6061-T6</b>	1	.338			Effective Immediately
707-084	4" x .375" x .12' <b>Alloy 6061-T6</b>	5	1.764			Effective September 10, 2018
707-090	1.5" x .375" x 12' <b>Alloy 6061-T6</b>	25	.661			Effective Immediately
707-096	1/2" x 6" x 12' FLAT BAR <b>Alloy 6061-T6</b>	15	3.528			Effective Immediately
707-097	1/4" x 12" x 12' FLAT BAR <b>Alloy 6061-T6</b>	50	3.528			Effective Immediately
707-098	1/4" x 6" x 12' FLAT BAR <b>Alloy 6061-T6</b>	10	1.764			Effective September 10, 2018

\*Substitute Alloy (6063-T2, 6063-T52, 6061-T6, 3003, 5052-H32, 6063, 6061-T6SS) as stated in description

**I-BEAMS****OVIEDO, FL**

"DOT" NUMBER	DESCRIPTION	ESTIMATED QUANTITY EACH	LBS LF	UNIT PRICE	TOTAL	
708-022	6" x 4" x .190" x 30' <b>Alloy 6061-T6</b>	10	4.030			Effective Immediately
708-042	4" x 3" x .29 x .17 x .25 x 25' <b>Alloy 6061-T6 *</b>	10	2.793			Effective Immediately

\*Substitute Alloy (6063-T2, 6063-T52, 6061-T6, 3003, 5052-H32, 6063, 6061-T6SS) as stated in description

**PLATES****OVIEDO, FL**

"DOT" NUMBER	DESCRIPTION	ESTIMATED QUANTITY EACH	LBS LF	UNIT PRICE	TOTAL	
704-095	.190" x 60" x 144" <b>Alloy 5052-H32</b>	20	2.740			<b>Effective Immediately</b>
704-120	.375" x 48" x 144" <b>Alloy 6061-T6</b>	10	5.290			<b>Effective Immediately</b>
704-130	.5" x 48" x 144" <b>Alloy 6061-T6</b>	10	7.000			Effective September 10, 2018
704-150	.75" x 48" x 144" <b>Alloy 6061-T6</b>	5	11.000			<b>Effective Immediately</b>
208-117	1/8" x 48" x 144" Brite Tread Plate <b>Alloy 3003 *</b>	25	1.900			Effective September 10, 2018

\*Substitute Alloy (6063-T2, 6063 T52, 6061 T6, 3003, 5052-H32, 6063, 6061-T6SS) as stated in description

**RODS****OVIEDO, FL**

"DOT" NUMBER	DESCRIPTION	ESTIMATED QUANTITY EACH	LBS LF	UNIT PRICE	TOTAL	
707-100	.375" x 12' <b>6061-T6 PER ASTM B 221</b>	10	.130			<b>Effective Immediately</b>
707-110	.75" x 12' <b>6061-T6 PER ASTM B 221</b>	10	.520			Effective September 10, 2018
707-120	.625" x 12' <b>6061-T6 PER ASTM B 221</b>	10	.361			Effective September 10, 2018
707-130	.875" x 12' <b>6061-T6 PER ASTM B 221</b>	10	.707			<b>Effective Immediately</b>
707-140	1" x 12' <b>6061-T6 PER ASTM B 221*</b>	10	.924			Effective September 10, 2018

**SHEETS****OVIEDO, FL**

"DOT" NUMBER	DESCRIPTION	ESTIMATED QUANTITY EACH	LBS LF	UNIT PRICE	TOTAL	
704-010	.08" x 48" x 144" <b>Alloy 5052-H32</b>	10	1.130			Effective Immediately
704-020	1/8" x 36" x 144" <b>Alloy 5052-H32 *</b>	10	1.764			Effective Immediately
704-040	1/8" x 48" x 144" <b>Alloy 5052-H32 *</b>	10	1.764			Effective Immediately
704-050	1/8" x 54" x 144" <b>Alloy 5052-H32 *</b>	40	1.764			Effective Immediately
704-060	1/8" x 60" x 144" <b>Alloy 5052-H32 *</b>	30	1.764			Effective Immediately
704-070	.125" x 48" x 192", Floor Plate <b>Alloy 6061-T6</b>	10	1.905			Effective Immediately
704-080	.1875" x 48" x 144" <b>Alloy 5052-H32 *</b>	20	2.740			Effective Immediately
704-090	.25" x 48" x 144" <b>Alloy 6061-T6</b>	3	3.530			Effective September 10, 2018

**ZEE-BEAMS****OVIEDO, FL**

"DOT" NUMBER	DESCRIPTION	ESTIMATED QUANTITY EACH	LBS	UNIT PRICE	TOTAL	
708-080	3" x .25" x 30' <b>Alloy 6061-T6</b>	20	2.330			Effective Immediately
708-100	4" x 3.0625" x .25" x 30' <b>Alloy 6061-T6</b>	20	2.850			Effective Immediately

**TUBES**

**OVIEDO, FL**

"DOT" NUMBER	DESCRIPTION	ESTIMATED QUANTITY EACH	LBS LF	UNIT PRICE	TOTAL	
702-005	1" x .125" x 20' <b>Alloy 6061-T6</b>	40	.405			Effective Immediately
702-010	1.5" x .125" x 12' <b>Alloy 6061-T6</b>	10	.635			Effective Immediately
702-015	1.75" x .125" x 24' <b>Alloy 6061-T6</b>	20	.750			Effective Immediately
702-025	2.25" x .125" x 30' <b>Alloy 6061-T6</b>	50	.981			Effective Immediately
702-030	2.5" x .25" x 30' <b>Alloy 6061-T6</b>	30	2.078			Effective Immediately
702-055	3.5" x .1875" x 24' <b>Alloy 6061-T6</b>	10	2.294			Effective Immediately
702-070	4" x .1875" x 24' <b>Alloy 6061-T6</b>	5	2.641			Effective Immediately
702-125	4.25" x .25" x 24' <b>Alloy 6061-T6</b>	1	3.695			Effective Immediately
702-131	4.5" x .375" x 24' <b>Alloy 6061-T6</b>	10	5.715			Effective Immediately
702-161	5" x .375" x 30' <b>Alloy 6061-T6</b>	25	6.408			Effective Immediately
702-162	5" x .5" x 24' <b>Alloy 6061-T6</b>	2	8.310			Effective Immediately
702-180	5.5" x .375 x 24' <b>Alloy 6061-T6</b>	5	7.101			Effective Immediately
702-185	5.5" x .25 x 24' <b>Alloy 6061-T6</b>	5	4.849			Effective Immediately
702-205	6" x .25" x 24' <b>Alloy 6061-T6</b>	2	5.311			Effective September 10, 2018
702-240	6.5" x .25" x 24' <b>Alloy 6061-T6</b>	1	5.773			Effective Immediately

**TUBES****OVIEDO, FL**

"DOT" NUMBER	DESCRIPTION	ESTIMATED QUANTITY EACH	LBS LF	UNIT PRICE	TOTAL	
702-265	7" x .375" x 24' <b>Alloy 6061-T6</b>	25	9.179			<b>Effective Immediately</b>
702-900	1.25" x .125" x 21', Square, <b>Alloy 6063-T52 *</b>	20	.675			Effective September 10, 2018
702-903	1-1/2" x 1-1/2" x 1/8" x 21', Square, <b>Alloy 6063-T52 *</b>	20	.80			Effective September 10, 2018
702-905	2" x 2" x .125" x 21', Square, <b>Alloy 6063-T52 *</b>	7	1.126			Effective September 10, 2018
702-910	2" x 4" x .125" x 21' Rectangle, <b>Alloy 6063-T52 *</b>	25	1.673			Effective September 10, 2018
702-913	2" x 4" x 1/4" x 24', Rectangle, <b>Alloy 6063-T52*</b>	20	3.201			Effective September 10, 2018
702-960	4" x 6" x .25" x 30' Rectangle <b>Alloy 6063-T52</b>	10	5.700			Effective September 10, 2018
702-961	2" x .25" x 21', Square <b>Alloy 6063-T52</b>	10	2.058			Effective September 10, 2018
702-962	1 1/2" x 3" x .187" x 21' Rectangle <b>Alloy 6063-T52</b>	20	1.250			<b>Effective Immediately</b>

\*Substitute Alloy (6063-T2, 6063-T52, 6061-T6, 3003, 5052-H32, 6063, 6061-T6SS) as stated in description

**OTHER****OVIEDO, FL**

"DOT" NUMBER	DESCRIPTION	ESTIMATED QUANTITY EACH	LBS	UNIT PRICE	TOTAL	
702-001	1" x 20' Schedule 40 Pipe <b>Alloy 6063-T6</b>	20	.581			<b>Effective Immediately</b>

Substitute Alloys – Sheets & Plates (6061-T6 & 5052-H32) except 208-117 which needs to be Alloy 3003.

Substitute Alloys – Tubing, Bars & Structural Shapes (6061-T6) on certain item (6063-T52).



## OTHER

## LAKE CITY, FL

"DOT" NUMBER	DESCRIPTION	ESTIMATED QUANTITY EACH	LBS	UNIT PRICE	TOTAL	
752-110	.08" x 36" Toll. See drawing 14 <b>Alloy 5052-H38</b>	100	1.117			Effective September 10, 2018
752-142	.08" x 24" Toll. See drawing 15 <b>Alloy 5052-H38</b>	100	1.117			Effective September 10, 2018
752-147	.08" x 48" Toll. See drawing 16 <b>Alloy 5052-H38</b>	10	1.764			Effective September 10, 2018

## ANGLE

STATEWIDE MAINTENANCE

DOT NUMBER	DESCRIPTION	ESTIMATED QUANTITY EACH	LBS LF	UNIT PRICE	TOTAL	
208-087	Extrusion, sign corner angle, See drawing #22-A5024 <b>Alloy 6063-T52</b>	500	1.100			Effective September 10, 2018

## TUBES

STATEWIDE MAINTENANCE

DOT NUMBER	DESCRIPTION	ESTIMATED QUANTITY EACH	LBS LF	UNIT PRICE	TOTAL	
	.125" x 2.5" x 17' <b>Alloy 6061-T6</b>	-	-			Effective Immediately
208-001	.125" x 2.5" x 34' <b>Alloy 6061-T6</b>	1,500	1.100			Effective Immediately
	.125" x 2" x 17' <b>Alloy 6061-T6</b>	-	-			Effective Immediately
208-002	.15628" x 2" x 34' <b>Alloy 6061-T6</b>	1,000	1.060			Effective Immediately
208-013	.125" x 3" x 17' <b>Alloy 6061-T6</b>	-	-			Effective Immediately
208-003	.125" x 3" x 34' <b>Alloy 6061-T6</b>	1,500	1.330			Effective Immediately
208-012	.15628" x 3.5" x 17' <b>Alloy 6061-T6</b>	-	-			Effective Immediately
208-004	.15625" x 3.5" x 34' <b>Alloy 6061-T6</b>	1,500	1.930			Effective Immediately

	.15625" x 4" x 17' <b>Alloy 6061-T6</b>	-	-			Effective Immediately
208-011	.15625" x 4" x 34' <b>Alloy 6061-T6</b>	600	2.220			Effective Immediately

**Z-BARS**

**STATEWIDE MAINTENANCE**

DOT NUMBER	DESCRIPTION	ESTIMATED QUANTITY EACH	LBS LF	UNIT PRICE	TOTAL	
208-558	1.75" x .1875" x 20' <b>Alloy 6061-T6</b>	225	1.080			Effective Immediately
208-517	3" x 2.6875" x .25" X 20' <b>Alloy 6061-T6</b>	600	2.333			Effective Immediately
208-088	Type-1 8-inch Bracket with Oval-rectangular holes, Top .75" x .375" Bottom 2" x .53125" Holes punched on 2" centers, See Table 26 and Drawing 1 <b>Alloy 6061-T6</b>	6,000				Effective Immediately
208-560	1.75" x 1.75" x .1875" x 10' With oval-rectangular holes, .375" x .75" punched on 2" Centers See Table 26 and Drawing 2 <b>Alloy 6061-T6</b>	1,500				Effective Immediately

**Z-BARS****STATEWIDE MAINTENANCE**

DOT NUMBER	DESCRIPTION	ESTIMATED QUANTITY EACH	LBS LF	UNIT PRICE	TOTAL	
208-095	1.75" x 1.75" x .1875" x 11" 11" Bracket with Oval- rectangular holes, Top .75" x .375" Bottom 2" x .53125" Holes punched on 2" centers, See Table 26 and Drawing 1 <b>Alloy 6061-T6</b>	<b>100</b>				<b>Effective Immediately</b>
208- 096	1.75" x 1.75" x .1875" x 14" 14" Bracket with Oval- rectangular holes, Top .75" x .375" Bottom 2" x .53125" Holes punched on 2" centers, See Table 26 and Drawing 1 <b>Alloy 6061-T6</b>	<b>100</b>				<b>Effective Immediately</b>
208-089	1.75" x 1.75" x .1875" x 20" 20" Bracket with Oval- rectangular holes, Top .75" x .375" Bottom 2" x .53125" Holes punched on 2" centers, See Table 26 and Drawing 1 <b>Alloy 6061-T6</b>	<b>100</b>				<b>Effective Immediately</b>
208-090	1.75" x 1.75" x .1875" x 26" 26" Bracket with Oval- rectangular holes, Top .75" x .375" Bottom 2" x .53125" Holes punched on 2" centers, See Table 26 and Drawing 1 <b>Alloy 6061-T6</b>	<b>100</b>				<b>Effective Immediately</b>

**Z-BARS****STATEWIDE MAINTENANCE**

DOT NUMBER	DESCRIPTION	ESTIMATED QUANTITY EACH	LBS LF	UNIT PRICE	TOTAL	
208-092	1.75" x 1.75" x .1875" x 32" 32" Bracket with Oval- rectangular holes, Top .75" x .375" Bottom 2" x .53125" Holes punched on 2" centers, See Table 26 and Drawing 1 <b>Alloy 6061-T6</b>	<b>100</b>				<b>Effective Immediately</b>
208-097	1.75" x 1.75" x .1875" x 38" 38" Bracket with Oval- rectangular holes, Top .75" x .375" Bottom 2" x .53125" Holes punched on 2" centers, See Table 26 and Drawing 1 <b>Alloy 6061-T6</b>	<b>100</b>				<b>Effective Immediately</b>
208- 093	1.75" x 1.75" x .1875" x 42" 42" Bracket with Oval- rectangular holes, Top .75" x .375" Bottom 2" x .53125" Holes punched on 2" centers, See Table 26 and Drawing 1 <b>Alloy 6061-T6</b>	<b>100</b>				<b>Effective Immediately</b>
208-098	1.75" x 1.75" x .1875" x 52" 52" Bracket with Oval- rectangular holes, Top .75" x .375" Bottom 2" x .53125" Holes punched on 2" centers, See Table 26 and Drawing 1 <b>Alloy 6061-T6</b>	<b>100</b>				<b>Effective Immediately</b>
208-094	1.75" x 1.75" x .1875" x 56" 56" Bracket with Oval- rectangular holes, Top .75" x .375" Bottom 2" x .53125" Holes punched on 2" centers, See Table 26 and Drawing 1 <b>Alloy 6061-T6</b>	<b>100</b>				<b>Effective Immediately</b>

**TUBES****STATEWIDE MAINTENANCE**

DOT NUMBER	DESCRIPTION	ESTIMATED QUANTITY EACH	LBS LF	UNIT PRICE	TOTAL	
TBD	.125" x 2.5" x 17' <b>Alloy 6061-T6</b>	1,500	1.100			Effective Immediately
TBD	.15628" x 2" x 17' <b>Alloy 6061-T6</b>	1,000	1.060			Effective Immediately
TBD	.125" x 3" x 17' <b>Alloy 6061-T6</b>	1,500	1.330			Effective Immediately
TBD	.15625" x 3.5" x 17' <b>Alloy 6061-T6</b>	1,500	1.930			Effective Immediately
TBD	.15625" x 4" x 17' <b>Alloy 6061-T6</b>	600	2.220			Effective Immediately

**DELIVERY:** Delivery will be made within \_\_\_\_\_ days after receipt of Purchase Order.

Is this product available with recycled content? \_\_Yes \_\_No

If yes, please send information separate from this Invitation to Bid (See Recycled Material Special Condition for more information).

**RENEWAL:** see Introduction Section #7.

THE UNIT PRICE(S) WILL APPLY TO THE INITIAL TERM AND ANY RENEWAL PERIODS.

**MFMP Transaction Fee:**

All payment(s) to the vendor resulting from this competitive solicitation **WILL** be subject to the MFMP Transaction Fee in accordance with the attached Form PUR 1000 General Contract Condition #14. The Transaction Fees imposed shall be based upon the date of issuance of the payment.

**NOTE:** In submitting a response, the bidder acknowledges they have read and agree to the solicitation terms and conditions and their submission is made in conformance with those terms and conditions.

**ACKNOWLEDGEMENT:** I certify that I have read and agree to abide by all terms and conditions of this solicitation and that I am authorized to sign for the bidder. I certify that the response submitted is made in conformance with all requirements of the solicitation.

Bidder: \_\_\_\_\_ FEID# \_\_\_\_\_

Address: \_\_\_\_\_ City, State, Zip: \_\_\_\_\_

Phone: \_\_\_\_\_ Fax: \_\_\_\_\_ E-mail: \_\_\_\_\_

Authorized Signature: \_\_\_\_\_ Date: \_\_\_\_\_

Printed/Typed: \_\_\_\_\_ Title: \_\_\_\_\_

STATE OF FLORIDA DEPARTMENT OF TRANSPORTATION  
**DRUG-FREE WORKPLACE PROGRAM CERTIFICATION**

375-040-18  
PROCUREMENT  
06/12

287.087 Preference to businesses with drug-free workplace programs. --Whenever two or more bids, proposals, or replies that are equal with respect to price, quality, and service are received by the state or by any political subdivision for the procurement of commodities or contractual services, a bid, proposal, or reply received from a business that certifies that it has implemented a drug-free workplace program shall be given preference in the award process. In order to have a drug-free workplace program, a business shall:

(1) Publish a statement notifying employees that the unlawful manufacture, distribution, dispensing, possession, or use of a controlled substance is prohibited in the workplace and specifying the actions that will be taken against employees for violations of such prohibition.

(2) Inform employees about the dangers of drug abuse in the workplace, the business's policy of maintaining a drug-free workplace, any available drug counseling, rehabilitation, and employee assistance programs, and the penalties that may be imposed upon employees for drug abuse violations.

(3) Give each employee engaged in providing the commodities or contractual services that are under bid a copy of the statement specified in subsection (1).

(4) In the statement specified in subsection (1), notify the employees that, as a condition of working on the commodities or contractual services that are under bid, the employee will abide by the terms of the statement and will notify the employer of any conviction of, or plea of guilty or nolo contendere to, any violation of Chapter 893 or of any controlled substance law of the United States or any state, for a violation occurring in the workplace no later than 5 days after such conviction.

(5) Impose a sanction on, or require the satisfactory participation in a drug abuse assistance or rehabilitation program if such is available in the employee's community by, any employee who is so convicted.

(6) Make a good faith effort to continue to maintain a drug-free workplace through implementation of this section.

**Does the individual responding to this solicitation certify that their firm has implemented a drug-free workplace program in accordance with the provision of Section 287.087, Florida Statutes, as stated above?**

YES

NO

NAME OF BUSINESS: \_\_\_\_\_

STATE OF FLORIDA DEPARTMENT OF TRANSPORTATION  
**IN-STATE PREFERENCE FORM**  
**For Invitation-to-Bid Commodity**

375-040-56  
PROCUREMENT  
OGC – 03/13

Bid Number: \_\_\_\_\_

Title: \_\_\_\_\_

Pursuant to Section 287.084, Florida Statutes, relating to the Florida-based business preference, effective July 1, 2012:

In a competitive solicitation in which the lowest bid is submitted by a vendor whose principal place of business is located outside the state of Florida and that state where the vendor's principal place of business is located does not grant a preference in competitive solicitation to vendors having a principal place of business in that state, the preference to the lowest responsible and responsive vendor having a principal place of business in this state shall be 5 percent.

**Note: The Vendor is required to complete and submit this form with its bid to be considered for this preference.**

Vendor Name: \_\_\_\_\_

Vendor FEIN: \_\_\_\_\_

The Vendor (does ) (does not ) have a principal place of business located in the state of Florida.

If so, please provide an address:

\_\_\_\_\_  
\_\_\_\_\_  
\_\_\_\_\_

**Note:** A vendor whose principal place of business is outside the state of Florida must accompany any written bid documents with a written opinion of an attorney licensed to practice law in that foreign state, as to the preferences, if any or none, granted by the law of that state to its own business entities whose principal places of business is in that foreign state in the letting of any or all public contracts.

Authorized Signature: \_\_\_\_\_

Title: \_\_\_\_\_

Date: \_\_\_\_\_

STATE OF FLORIDA DEPARTMENT OF TRANSPORTATION  
**VENDOR CERTIFICATION REGARDING  
SCRUTINIZED COMPANIES LISTS**

Respondent Vendor Name: \_\_\_\_\_  
Vendor FEIN: \_\_\_\_\_  
Vendor's Authorized Representative Name and Title: \_\_\_\_\_  
Address: \_\_\_\_\_  
City: \_\_\_\_\_ State: \_\_\_\_\_ Zip: \_\_\_\_\_  
Phone Number: \_\_\_\_\_  
Email Address: \_\_\_\_\_

Section 287.135, Florida Statutes, prohibits agencies from contracting with companies for goods or services of \$1,000,000 or more, that are on either the Scrutinized Companies with Activities in Sudan List, the Scrutinized Companies with Activities in the Iran Petroleum Energy Sector Lists which are created pursuant to s. 215.473, F.S., or the Scrutinized Companies that Boycott Israel List, created pursuant to s. 215.4725, F.S., or companies that are engaged in a boycott of Israel.

As the person authorized to sign on behalf of Respondent, I hereby certify that the company identified above in the section entitled "Respondent Vendor Name" is not listed on either the Scrutinized Companies with Activities in Sudan List or the Scrutinized Companies with Activities in the Iran Petroleum Energy Sector List, or the Scrutinized Companies that Boycott Israel List. I further certify that the company is not engaged in a boycott of Israel. I understand that pursuant to section 287.135, Florida Statutes, the submission of a false certification may subject company to civil penalties, attorney's fees, and/or costs.

Certified By: \_\_\_\_\_  
who is authorized to sign on behalf of the above referenced company.  
Authorized Signature Print Name and Title: \_\_\_\_\_  
Date: \_\_\_\_\_



**ORDERING INSTRUCTIONS**

Bid Number: ITB-DOT-17/18-9106-KW

Title: ALUMINUM MATERIALS

**NOTE: ALL ORDERS SHOULD BE DIRECTED TO:**

FEDERAL EMPLOYER IDENTIFICATION NUMBER (FEID): \_\_\_\_\_

VENDOR: \_\_\_\_\_

ADDRESS: \_\_\_\_\_

CITY, STATE, ZIP: \_\_\_\_\_

TELEPHONE: \_\_\_\_\_

TOLL FREE NO.: \_\_\_\_\_ FAX NO.: \_\_\_\_\_

DELIVERY: DELIVERY WILL BE MADE WITHIN \_\_\_\_\_ DAYS AFTER RECEIPT  
OF PURCHASE ORDER.

PRODUCT INFORMATION: DIRECT QUESTIONS TO:

NAME & TITLE: \_\_\_\_\_

ADDRESS: \_\_\_\_\_

CITY, STATE, ZIP: \_\_\_\_\_

TELEPHONE: \_\_\_\_\_

TOLL FREE NO.: \_\_\_\_\_ FAX NO.: \_\_\_\_\_

E-MAIL ADDRESS: \_\_\_\_\_

WEB ADDRESS: \_\_\_\_\_

Will you accept the State of Florida Purchasing Card (VISA)?  Yes  No

**State of Florida  
Department of Transportation**



INVITATION TO BID  
**ALUMINUM MATERIALS**

**ITB-DOT-17/18-9106-KW**

**CONTACT FOR QUESTIONS:**

Katie Wagner, Procurement Agent  
605 Suwannee Street, Mail Station 20  
Tallahassee, Florida 32399-0450  
Katie.wagner@dot.state.fl.us  
Phone: (850) 414-4956

# INTRODUCTION SECTION

## 1) INVITATION

The purpose of this Invitation to Bid is to obtain competitive bids to establish a two (2) year contract for the purchase of Aluminum Materials by the Department of Transportation, hereafter referred to as the "Department". The contract will become effective on the date the successful bidder(s) is approved for award and will expire two years from that date. After the award, said bidder(s) will be referred to as the "Vendor(s)".

All commodities identified in this Invitation to Bid will be subject to the availability of identical commodities as provided by mandatory Department of Management Services' State Contract(s) at such time these commodities become available. In the event of duplication(s) of commodities, the Department of Management Services' mandatory State Contract shall prevail.

## 2) TIMELINE

Provided below is a list of critical dates and actions. These dates are subject to change. Notices of changes (Addenda) will be posted on the Florida Vendor Bid System at [www.myflorida.com](http://www.myflorida.com) (click on "BUSINESS", click on "Doing Business with the State", under "Everything for Vendors and Customers", click on "Vendor Bid System (VBS)", click on "Search Advertisements") under this bid number. It is the responsibility of all potential bidders to monitor this site for any changing information prior to submitting your bid.

<u>ACTION / LOCATION</u>	<u>DATE</u>	<u>LOCAL TIME</u>
<b>DEADLINE FOR TECHNICAL QUESTIONS -</b> (There is no deadline for administrative questions)	<b>06-21-2018</b>	<b>5:00 PM</b>
<b>BIDS DUE (ON OR BEFORE) -</b> Florida Department of Transportation Central Procurement Office Attn: Katie Wagner 605 Suwannee Street, MS 20 Tallahassee, Florida 32399-0450 850-414-4956	<b>06-28-2018</b>	<b>3:00 PM</b>
<b>PUBLIC OPENING -</b> Florida Department of Transportation Central Procurement Office 605 Suwannee Street, MS 20 Tallahassee, Florida 32399-045	<b>06-28-2018</b>	<b>3:00 PM</b>
<b>POSTING OF INTENDED DECISION/AWARD -</b>	<b>07-03-2018</b>	<b>5:00 PM</b>

## 3) BID OPENING AGENDA

The sealed bids will be opened by the Department's Procurement Office personnel at the date, time and location in the Timeline. All bid openings are open to the public and will be conducted according to the following agenda:

Opening remarks – Approximate time of 2 minutes by Department Procurement Office personnel.

Public input period – To allow a maximum of 15 minutes total for public input related to the bid solicitation.

Bids opened – At conclusion of public input or 15 minutes, whichever occurs first, bids received timely will be opened with bidder's name and prices to be read aloud.

Adjourn - After all bids received timely have been opened, the meeting will be adjourned.

#### **4) SPECIAL ACCOMMODATIONS**

Any person with a qualified disability requiring special accommodations at a pre-bid conference, public meeting, and/or opening shall contact the contact person at the phone number, e-mail address or fax number provided on the title page at least five (5) working days prior to the event. If you are hearing or speech impaired, please contact this office by using the Florida Relay Services which can be reached at 1 (800) 955-8771 (TDD).

#### **5) CONTRACT USE**

Use of the contract resulting from this bid will be optional for the Department. The Department reserves the right to solicit separate bids for any unusual or abnormal quantity requirements that may arise during the term of the contract.

#### **6) ESTIMATED PURCHASES**

The Department anticipates purchasing the estimated quantities, shown on the bid sheet(s), for a one (1) year period of any contract resulting from this bid. The estimated quantities are given only as a guideline for preparing your bid and should not be construed as representing the actual quantities to be purchased under this contract. The Vendor(s) shall supply, at bid prices, the actual quantities ordered regardless of whether the total of such quantities is more or less than anticipated. This bid and the resulting contract will be subject to annual appropriated funding.

#### **7) RENEWAL**

Upon mutual agreement, the Department and the Contract Vendor may renew the contract for a period that may not exceed 3 years or the term of the original contract, whichever is longer. The renewal must be in writing and signed by both parties, and is subject to the same terms and conditions set forth in the initial contract and any written amendments signed by the parties. Any renewal shall specify the renewal price, as set forth in the solicitation response except that an agency may negotiate lower pricing. Renewal is contingent upon satisfactory performance evaluations and subject to the availability of funds.

## **SPECIAL CONDITIONS**

#### **1) MyFloridaMarketPlace**

BIDDERS MUST BE ACTIVELY REGISTERED IN THE STATE OF FLORIDA'S MYFLORIDAMARKETPLACE SYSTEM BY THE TIME AND DATE OF THE BID OPENING OR THEY MAY BE CONSIDERED NON-RESPONSIVE (see Special Condition 21). All prospective bidders that are not registered should go to <https://vendor.myfloridamarketplace.com/> to complete on-line registration, or call 1-866-352-3776 for assisted registration.

All payment(s) to the vendor resulting from this competitive solicitation **WILL** be subject to the MFMP Transaction Fee in accordance with the referenced Form PUR 1000 General Contract Condition #14. However, all vendors should be aware, that effective July 1, 2016 through June 30, 2017, in accordance with House Bill 5003 Sec.73, the Transaction Fee will be seven-tenths of one percent (.70%) of the payment issued. The Transaction Fees imposed shall be based upon the date of issuance of the payment.

#### **2) Florida Department of Financial Services (DFS) W-9 REQUIREMENT**

The Florida Department of Financial Services (DFS) requires all vendors that do business with the state to submit an electronic Substitute Form W-9. Vendors must submit their W-9 forms electronically at <https://flvendor.myfloridacfo.com> to receive payments from the state. Contact the DFS Customer Service

Desk at (850) 413-5519 or [FLW9@myfloridacfo.com](mailto:FLW9@myfloridacfo.com) with any questions.

### 3) **QUESTIONS & ANSWERS**

In accordance with section 287.057(23), Florida Statutes, respondents to this solicitation or persons acting on their behalf may not contact, between the release of the solicitation and the end of the 72-hour period following the agency posting the notice of intended award, excluding Saturdays, Sundays, and state holidays, any employee or officer of the executive or legislative branch concerning any aspect of this solicitation, except in writing to the procurement officer or as provided in the solicitation documents. Violation of this provision may be grounds for rejecting a response.

Any technical questions arising from this Invitation to Bid must be forwarded, in writing, to the procurement agent identified below. Questions must be received no later than the time and date reflected on the Timeline. The Department's written response to written inquiries submitted timely by bidders will be posted on the Florida Vendor Bid System at [www.myflorida.com](http://www.myflorida.com) (click on "BUSINESS", click on "Doing Business with the State", under "Everything for Vendors and Customers", click on "Vendor Bid System (VBS)", click on "Search Advertisements"), under this bid number. It is the responsibility of all potential bidders to monitor this site for any changing information prior to submitting their bid.

**WRITTEN TECHNICAL QUESTIONS** should be submitted to:

**FDOT Procurement Office**

**Attn: Katie Wagner**

**605 Suwannee, Street, Mail Station 20, Tallahassee, Florida 32399-0450**

**or [Katie.wagner@dot.state.fl.us](mailto:Katie.wagner@dot.state.fl.us)**

Questions regarding administrative aspects of the bid process should be directed to the Procurement Agent in writing at the address above or by phone: (850)-414-4956

### 4) **ORAL INSTRUCTIONS / CHANGES TO THE INVITATION TO BID (ADDENDA)**

No negotiations, decisions, or actions will be initiated or executed by a bidder as a result of any oral discussions with a State employee. Only those communications which are in writing from the Department will be considered as a duly authorized expression on behalf of the Department.

Notices of changes (Addenda) will be posted on the Florida Vendor Bid System at [www.myflorida.com](http://www.myflorida.com) (click on "BUSINESS", click on "Doing Business with the State", under "Everything for Vendors and Customers", click on "Vendor Bid System (VBS)", click on "Search Advertisements") under this bid number. It is the responsibility of all potential bidders to monitor this site for any changing information prior to submitting your bid. All Addenda will be acknowledged by signature and subsequent submission of Addenda with bid when so stated in the Addenda.

### 5) **DIVERSITY ACHIEVEMENT**

The Department, in accordance with ***Title VI of the Civil Rights Act of 1964, 42 USC 2000d- 2000d-4, Title 49, Code of Federal Regulations, U.S. Department of Transportation, Subtitle A, Office of the Secretary, Part 21***, Nondiscrimination in federally-assisted programs of the Department of Transportation issued pursuant to such Act, hereby notifies all bidders that the Department will affirmatively ensure that in any contract/agreement entered into pursuant to this advertisement, minority and disadvantaged business enterprises will be afforded the full opportunity to submit bids in response to this invitation and will not be discriminated on the basis of race, color, national origin, or sex in consideration for an award.

The Department encourages the recruitment and utilization of small, minority, women, and service-disabled veteran businesses. The Department, its vendors, suppliers, and consultants should take all necessary and

reasonable steps to ensure that small, minority, women, and service-disabled veteran businesses have the opportunity to compete for and perform contract work for the Department in a nondiscriminatory environment.

## 6) **PRICES/DELIVERY**

Prices shall be firm, net, delivered prices, F.O.B. destination.

Delivery must be made within thirty (30) calendar days or less upon receipt of a purchase order by the contract vendor at their designated ordering location. If more time is needed, the bidder should state the extra time required and the reasons why, in their bid response. Acceptance will be subject to the Department's approval.

## 7) **IN-STATE PREFERENCE FOR COMMODITY BIDS**

In accordance with Section 287.084, Florida Statutes, when the lowest responsible and responsive bid is submitted by a vendor whose principal place of business is located outside the state of Florida, a 5% price preference shall be awarded to the lowest responsible and responsive vendor whose principal place of business is located in the state of Florida unless the state where the out-of-state vendor is located provides a price preference for businesses having a principal place of business in that state. In that case, the same price preference shall be awarded to the lowest responsible and responsive vendor whose principal place of business is located in the state of Florida responding to this Invitation to Bid (ITB).

**All bidders should complete the attached "In-State Preference Form" and submit with their bid response.** A vendor whose principal place of business is located outside the state of Florida, as determined by the vendor's registration with the Florida Department of State, **must accompany their bid response documents** with a written opinion of an attorney licensed to practice law in that foreign state, as to the preferences granted by that state to its own business entities in the letting of public contracts. **Failure of a vendor, whose principal place of business is located outside the state of Florida, to submit the aforementioned written opinion shall result in a non-responsive reply.**

For the 5% preference, the Department will apply 5% to the bid price(s) of the lowest out of state vendor whose state does not grant a preference if that vendor has submitted the lowest responsible and responsive bid. The "In-State Preference" does not apply to transportation projects that use federal funds.

## 8) **INTENDED AWARD**

As the best interest of the State may require, the right is reserved to make award(s) by individual item, group of items, all or none, or a combination thereof: on a geographical district basis and / or on a statewide basis with one or more suppliers to reject any and all bids or waive any minor irregularity or technicality in bids received. When it is determined there is competition to the lowest responsible bidder, evaluation of other bids is not required. Bidders are cautioned to make no assumptions, unless their bid has been evaluated as being responsive. All awards made as a result of this bid shall conform to applicable Florida Statute. If the Department is confronted with identical pricing or scoring from multiple vendors, the Department shall determine the order of award in accordance with section 295.187(4), Florida Statutes, and Rule 60A-1.011 Florida Administrative Code.

9) **PRE-BID CONFERENCE:** A PRE-BID CONFERENCE WILL NOT BE HELD.

## 10) **ALTERNATES**

ALTERNATE BRANDS WILL NOT BE CONSIDERED FOR THIS BID. BID AS SPECIFIED.

## **11) WARRANTY/SUBSTITUTIONS**

A warranty is required on all items purchased against defective materials, workmanship, and failure to perform in accordance with required industry performance criteria, for a period of not less than ninety (90) days from the date of acceptance by the purchaser. Any deviation from this criteria must be documented in the bid response or the above statement shall prevail. Delivery of substitute commodities requires prior written approval from the ordering location.

## **12) REPLACEMENT/RESTOCKING**

Replacement of all materials found defective within the warranty period shall be made without cost to the purchaser, including transportation if applicable. All fees associated with restocking cancelled orders shall be the responsibility of the vendor.

## **13) PRODUCT REQUIREMENTS/SPECIFICATIONS**

Items furnished shall be standard products of the manufacturer or their suppliers, shall be new, unused, clean, and free from any defects or features affecting appearance, serviceability, or the safety of the user in normal intended use.

Any deviation from specifications indicated herein must be clearly pointed out; otherwise, it will be considered that items offered are in strict compliance with these specifications, and successful bidder will be held responsible therefore. Deviations must be explained in detail on separate attached sheet(s).

## **14) ACCEPTANCE**

All items listed in the specifications, delivered to the Department not meeting specifications or found to be poorly manufactured will not be accepted, but returned to the vendor, at their expense, for replacement. Replacement of all items found defective shall be made without cost to the Department, including transportation, if applicable. As it may be impossible for each facility to inspect all items upon arrival, a reasonable opportunity must be given to these facilities for inspection of the items, and returning those that are defective.

## **15) REVIEW OF BIDDER'S FACILITIES & QUALIFICATIONS**

After the bid due date and prior to contract execution, the Department reserves the right to perform or to have performed, an on-site review of the bidder's facilities and qualifications. This review will serve to verify data and representations submitted by the bidder and may be used to determine whether the bidder has adequate facilities, equipment, qualified and experienced staff, and overall management capabilities to provide the required items. The review may also serve to verify whether the bidder has financial capabilities adequate to meet the contract requirements.

**Should** the Department determine that the bid package has material misrepresentations or that the size or nature of the bidder's facilities, equipment, management capabilities, or the number of experienced personnel (including technical staff) are not adequate to ensure satisfactory contract performance, the Department has the right to reject the bid.

## **16) PROTEST OF INVITATION TO BID SPECIFICATIONS**

Any person who is adversely affected by the contents of this Invitation to Bid must file the following with the Department of Transportation, Clerk of Agency Proceedings, Office of the General Counsel, 605 Suwannee Street, Mail Station 58, Tallahassee, Florida 32399-0450:

1. A written notice of protest within seventy-two (72) hours after the posting of the solicitation, (the notice of protest may be Faxed to 850-414-5264), and

2. A formal written protest in compliance with Section 120.57(3), Florida Statutes, within ten (10) days of the date on which the written notice of protest is filed.

Failure to file a protest within the time prescribed in section 120.57(3), Florida Statutes, or failure to post the bond or other security required by law within the time allowed for filing a bond shall constitute a waiver of proceedings under Chapter 120, Florida Statutes.

#### **17) UNAUTHORIZED ALIENS**

The employment of unauthorized aliens by any contractor is considered a violation of Section 274A(e) of the Immigration and Nationality Act. If the contractor knowingly employs unauthorized aliens, such violation shall be cause for unilateral cancellation of the contract.

#### **18) SCRUTINIZED COMPANIES LISTS**

Responses of \$1 million or more must include a completed [Vendor Certification Regarding Scrutinized Companies Lists](#) to certify the respondent is not on either of those lists. The Form should be submitted with the Price Proposal.

Section 287.135, Florida Statutes, requires that at the time a vendor submits a bid or proposal for a contract for goods or services of \$1,000,000 or greater, the vendor must certify that the company is not on Scrutinized Companies with Activities in the Sudan List, the Scrutinized Companies with Activities in the Iran Petroleum Energy Sector List, or the Scrutinized Companies that Boycott Israel List.

For Contracts \$1,000,000 and greater, if the Department determines the Vendor submitted a false certification under Section 287.135(5) of the Florida Statutes, or if the Vendor has been placed on the Scrutinized Companies with Activities in the Sudan List, the Scrutinized Companies with Activities in the Iran Petroleum Energy Sector List, or the Scrutinized Companies that Boycott Israel List, the Department shall either terminate the Contract after it has given the Vendor notice and an opportunity to demonstrate the Department's determination of false certification was in error pursuant to Section 287.135(5)(a) of the Florida Statutes, or maintain the Contract if the conditions of Section 287.135(4) of the Florida Statutes are met.

#### **19) RESERVATIONS**

The Department reserves the right to accept or reject any or all bids received and reserves the right to make an award without further discussion of the bids submitted. Therefore, the bidder should make sure that the bid package submitted is complete and accurate and submitted to ensure delivery on or before the bid opening time and date specified in this solicitation. It is understood that the bid will become a part of the Department's official file, without obligation to the Department.

#### **20) ADDITIONAL TERMS & CONDITIONS**

No conditions may be applied to any aspect of the ITB by the bidder. Any conditions placed on any aspect of the bid documents by the bidder may result in the bid being rejected as a conditional bid (see "RESPONSIVENESS OF BIDS"). **DO NOT WRITE IN CHANGES ON ANY ITB SHEET.** The only recognized changes to the ITB prior to bid opening will be a written Addenda issued by the Department.

#### **21) RESPONSIVENESS OF BIDS**

Bids will not be considered if not received by the Department **on or before** the date and time specified as the due date for submission. All bids must be typed or printed in ink. A responsive bid is an offer to provide the items specified in this Invitation to Bid in accordance with all requirements of this Invitation to Bid. Bids found to be non-responsive will not be considered. Bids may be rejected if found to be irregular or not in



conformance with the specifications and instructions herein contained. A bid may be found to be irregular or non-responsive by reasons that include, but are not limited to, failure to utilize or complete prescribed forms, modifying the bid specifications, submitting conditional bids or incomplete bids, submitting indefinite or ambiguous bids, or executing forms or the bid sheet with improper and/or undated signatures. Other conditions which may cause rejection of bids include, evidence of collusion among bidders, obvious lack of experience or expertise to provide the required items, and failure to perform or meet financial obligations on previous contracts.

## **22) REQUIRED DOCUMENTS**

The bidder must use the attached Bid Sheet to submit its bid. The Bid Sheet must be signed and dated in ink by a representative who is authorized to contractually bind the bidder. All bid sheets and other documentation submitted in response to this solicitation must be executed and submitted in a sealed envelope. **Indicate the bid number, with the time and date of the bid opening, on the envelope used to return the bid.**

## **23) "DRUG-FREE WORK PLACE" PREFERENCE**

Whenever two or more bids which are equal with respect to price, quality, and service are received, the Department shall determine the order of award in accordance with section 295.187(4), Florida Statutes, and Rule 60A-1.011 Florida Administrative Code, which includes a preference for bid responses that certify the business has implemented a drug-free workplace program in accordance with Section 287.087, F.S. The "Drug-Free Workplace Program Certification" must be completed and submitted with the bid response to be eligible for this preference.

## **24) COPYRIGHTED MATERIAL**

Copyrighted material will be accepted as part of a bid only if accompanied by a waiver that will allow the Department to make paper and electronic copies necessary for the use of Department staff and agents. It is noted that copyrighted material is not exempt from the Public Records Law, Chapter 119, Florida Statutes. Therefore, such material will be subject to viewing by the public, but copies of the material will not be provided to the public.

## **25) ATTACHMENT TO ITB SUBMITTAL - CONFIDENTIAL MATERIAL**

The Bidder must include any materials it asserts to be exempted from public disclosure under Chapter 119, Florida Statutes, in a separate bound document labeled "Attachment to Invitation to Bid, Number ITB-DOT-17-18-9106-KW - Confidential Material". The Bidder must identify the specific Statute that authorizes exemption from the Public Records Law. Any claim of confidentiality on materials the Bidder asserts to be exempt from public disclosure and placed elsewhere in the bid will be considered waived by the Bidder upon submission, effective after opening.

## **26) MAIL OR DELIVER BIDS TO: (DO NOT FAX OR SEND BY E-MAIL)**

**Florida Department of Transportation  
Central Procurement Office  
Attn: Katie Wagner, Procurement Office  
605 Suwannee Street, Mail Station 20  
Tallahassee, Florida 32399-0450  
Phone: (850) 414-4956**

It is the bidder's responsibility to assure that the bid is delivered to the proper place **on or before** the Bid Due date and time (See Introduction Section 2, Timeline). Bids which for any reason are not so delivered will not be considered.

## **27) MODIFICATIONS, RESUBMITTAL AND WITHDRAWAL**

Bidders may modify submitted bids at any time prior to the bid due date. Requests for modification of a submitted bid shall be in writing and must be signed by an authorized signatory of the bidder. Upon receipt and acceptance of such a request, the entire bid will be returned to the bidder and not considered unless resubmitted by the due date and time. Bidders may also send a change in a sealed envelope to be opened at the same time as the bid. The ITB number, opening date and time should appear on the envelope of the modified bid.

## **28) POSTING OF INTENDED DECISION/AWARD**

### **28.1 General:**

The Department's decision will be posted on the Florida Vendor Bid System at [www.myflorida.com](http://www.myflorida.com), (click on "BUSINESS", click on "Doing Business with the State", under "Everything for Vendors and Customers", click on "Vendor Bid System (VBS)", on date and time in the Timeline, and will remain posted for a period of seventy-two (72) hours. Any bidder who is adversely affected by the Department's recommended award or intended decision must file the following with the Department of Transportation, Clerk of Agency Proceedings, Office of the General Counsel, 605 Suwannee Street, Mail Station 58, Tallahassee, Florida 32399-0450:

1. A written notice of protest within seventy-two (72) hours after posting of the Intended Award, (the notice of protest may be Faxed to 850-414-5264), and
2. A formal written protest and protest bond in compliance with Section 120.57(3), Florida Statutes, within ten (10) days of the date on which the written notice of protest is filed. At the time of filing the formal written protest, a bond (a cashier's check or money order may be accepted) payable to the Department must also be submitted in an amount equal to one percent (1%) of the estimated contract amount based on the contract price submitted by the protestor.

Failure to file a protest within the time prescribed in Section 120.57(3), Florida Statutes, or failure to post the bond or other security required by law within the time allowed for filing a bond shall constitute a waiver of proceedings under Chapter 120, Florida Statutes.

### **28.2 Inability to Post:**

If the Department is unable to post as defined above, the Department will notify all bidders by electronic notification on the Florida Vendor Bid System (see special condition 28.1, above) or by mail, fax, and/or telephone. The Department will provide notification of any future posting in a timely manner.

### **28.3 Request to Withdraw Bid:**

Requests for withdrawal will be considered if received by the Department, in writing, within seventy-two (72) hours after the bid opening time and date. Requests received in accordance with this provision will be granted by the Department upon proof of the impossibility to perform based upon obvious error on the part of the bidder. Bidders that do not withdraw as stated above will forfeit their bid bond, if applicable.

## **29) RECYCLED MATERIAL**

The Department encourages the use of products and materials with recycled content and post-consumer recovered materials. If the item(s) specified in the Technical Specification is available with recycled content, we request that you provide product information to help in our search for recycled products. However, this bid request is for the product as specified herein and does not require prices for recycled product. This information should be sent as part of your bid response or may be sent separately.

### **30) PRICE ADJUSTMENTS**

The Department may, in its sole discretion, make an equitable adjustment in the Contract terms and/or pricing if pricing or availability of supply is affected by extreme and unforeseen volatility in the marketplace, that is, by circumstances that satisfy all the following criteria: (1) the volatility is due to causes wholly beyond the Vendor's control, (2) the volatility affects the marketplace or industry, not just the particular Contract source of supply, (3) the effect on pricing or availability of supply is substantial, and (4) the volatility so affects the Vendor that continued performance of the Contract would result in a substantial loss. The Vendor shall provide thirty (30) days written notice to the Department and written approval from the Department is required. Documentation of cost adjustments shall be provided by the Vendor to the Department.

### **31) PRICE ADJUSTMENTS**

Delivery shall be as specified on the purchase orders. Normally, delivery shall be to the following sites:

Ms. Janelle Inman-Albright, Phone: 386/961-7120 \*

Department of Transportation, Sign Shop

590 NW Lake Jeffery Road

Lake City, FL 32055

OR

Mr. Rishi Moonian, Phone: 407/977-6520 \*\*

Department of Transportation

State Aluminum Structures Shop (SASS)

2590 Camp Road

Oviedo, FL 32765

Deliver on flatbed vehicle with removable sides for forklift operations. The load will be positioned for unloading with moving or off-loading items not for that location.

\* Deliveries shall be made between 8:00 A.M. and 4:00 P.M. Monday through Thursday. No Friday or holiday deliveries

\*\* Deliveries shall be made between 8:00 A.M. and 3:00 P.M. Monday through Thursday. No Friday or holiday deliveries

### **32) PACKAGING**

Each Commodity number for the Lake City, Florida location should be palletized separately.

### **33) CANCELLATION**

All contract obligations shall prevail for at least one hundred and eighty (180) days after the effective date of the contract. For the protection of both parties, this contract may be cancelled in whole or in part after one hundred and eighty (180) days by either party giving thirty (30) days prior written notice to the other contract party. The contract may, also, be cancelled by the Department for nonperformance (default) in accordance with Rule 60A-1.006(3), F.A.C.

### **34) ORDERING INSTRUCTIONS**

Manufacturers are encouraged to bid direct naming dealers who will accept orders and complete deliveries. Bidders must include complete ordering instructions, including FEDERAL EMPLOYER IDENTIFICATION NUMBER (FEID), for invoicing dealers, with the bid on a separate sheet.

### **35) ORDER QUANTITIES**

The Department will, at its discretion, place orders with the Vendor(s) for various quantities of the items, as needed, during the contract period. Bidders are encouraged to identify the standard packaging quantity and minimum order quantity acceptable for each item or group of items bid. **Excessive minimum order quantities will not be accepted.**

### **36) OPEN PURCHASE ORDERS**

The Department may, at its discretion, establish an open (estimated quantity) purchase order with the contract vendor(s) to facilitate the purchasing of materials. The purchase of materials may be placed by; (1) written purchase order, (2) telephone orders by authorized Department personnel, or (3) an itemized order in writing. The Department will supply the contract vendor(s) with a list of personnel authorized to order. Delivery of items on these open purchase orders shall not exceed the contract effective period.

### **37) INVOICING**

Invoices must match units specified on the Purchase Order.

### **38) FORMS**

The Bidder must complete all required items below and submit them as part of the Bid package. Any Bid in which these forms are not used or in which these forms are improperly executed may be considered non-responsive and the bid may be subject to rejection.

Bid Sheet

Drug-Free Workplace Program Certification (if applicable)

In-State Preference

Vendor Certification Regarding Scrutinized Companies Lists (Form 375-030-60) (proposals of \$1 million or more

Certification of Recycled Content (if applicable)

Ordering Instructions

### **39) TERMS AND CONDITIONS**

#### **39.1 General Contract Conditions (PUR 1000)**

The State of Florida's General Contract Conditions are outlined in form PUR 1000, which is a downloadable document incorporated into this Invitation to Bid (ITB) by reference. Any terms and conditions set forth in this ITB document will take precedence over the PUR 1000 form where applicable.

<http://www.dms.myflorida.com/content/download/2933/11777/1000.pdf>

The following paragraphs do not apply to this Invitation to Bid:

Paragraph 31, Dispute Resolution - PUR 1000

Paragraph 40, PRIDE – PUR 1000, when federal funds are utilized.

#### **39.2 General Instructions to Respondents (PUR 1001)**

The State of Florida's General Instructions to Respondents are outlined in form PUR 1001, which is a downloadable document incorporated into this Invitation to Bid (ITB) by reference. Any terms and conditions set forth in this ITB document take precedence over the PUR 1001 form where applicable.

<http://www.dms.myflorida.com/content/download/2934/11780/1001.pdf>

The following paragraphs do not apply to this Invitation to Bid:

Paragraph 3, Electronic Submission – PUR 1001

Paragraph 4, Terms and Conditions – PUR 1001

Paragraph 5, Questions – PUR 1001

### **39.3 MFMP Purchase Order Terms and Conditions**

All MFMP Purchase Order contracts resulting from this solicitation will include the terms and conditions of this solicitation and the State of Florida's standardized Purchase Order Terms and Conditions, which can be found at the Department of Management Services website at the following link:

[http://www.dms.myflorida.com/content/download/117735/646919/Purchase\\_Order\\_Terms\\_Sept\\_1,\\_2015\\_.pdf](http://www.dms.myflorida.com/content/download/117735/646919/Purchase_Order_Terms_Sept_1,_2015_.pdf)

Section 8(B), PRIDE, is not applicable when using federal funds.

### **40) ORDER OF PRECEDENCE**

All responses are subject to the terms and conditions of this solicitation, which, in case of conflict, shall have the following order of precedence listed:

Special Conditions

Technical Specifications

Bid Sheet

MFMP Purchase Order Terms and Conditions – Section 8(B), PRIDE, is not applicable when using federal funds.

General Instructions to Respondents (PUR 1001)

General Contract Conditions (PUR 1000)

Introduction Section

### **41) QUALITY CONTROL PLAN**

All producers/fabricators of aluminum are required to have an approved quality control plan in accordance

with FDOT specifications and be listed on the State Materials Office list of approved metal producers, which can be accessed on their website.

**Questions concerning the quality control plan should be directed to:**

Steven M. Duke, CPM, Inspection Services Manager (Structural Steel, Coatings, and Timber),

State Materials Office

5007 NE 39th Ave.

Gainesville, FL 32609

Office: (352) 955-6682

[Steve.Duke@dot.state.fl.us](mailto:Steve.Duke@dot.state.fl.us)

### **42) MATERIAL SPECIFICATIONS – COMPLIANCE FORM**

A completed copy of this page, filled out in ink, must be returned with the bid. Failure to complete the conformance column may result in a bid being rejected as non-responsive. Unless otherwise stated this data applies to all sites.

Vendor Name: \_\_\_\_\_

### QUALITY CONTROL PLAN FORM

All producers/fabricators of aluminum are required to have an approved quality control plan in accordance with FDOT specifications and be listed on the State Materials Office list of approved metal producers, which can be accessed on their website. Questions concerning the Quality Control Plan (QCP) should be directed to: Steven M. Duke, CPM, Inspection Services Manager (Structural Steel, Coatings, and Timber), State Materials Office, 5007 NE 39th Ave., Gainesville, FL 32609, Office (352) 955-6682. **This has to be completed by the award posting date.**

#### ALL ITEMS ARE CONSIDERED FABRICATED.

Please provide the following information all manufacturer(s) that you will be using for any contract item.

Manufacturer Name: \_\_\_\_\_  
Contact Person: \_\_\_\_\_  
City, State, Zip Code: \_\_\_\_\_  
Phone Number: \_\_\_\_\_  
Email Address: \_\_\_\_\_  
Source Number (if available) (\*): \_\_\_\_\_  
Category Type Purchased (\*\*): \_\_\_\_\_

Manufacturer Name: \_\_\_\_\_  
Contact Person: \_\_\_\_\_  
City, State, Zip Code: \_\_\_\_\_  
Phone Number: \_\_\_\_\_  
Email Address: \_\_\_\_\_  
Source Number (if available) (\*): \_\_\_\_\_  
Category Type Purchased (\*\*): \_\_\_\_\_

Manufacturer Name: \_\_\_\_\_  
Contact Person: \_\_\_\_\_  
City, State, Zip Code: \_\_\_\_\_  
Phone Number: \_\_\_\_\_  
Email Address: \_\_\_\_\_  
Source Number (if available) (\*): \_\_\_\_\_  
Category Type Purchased (\*\*): \_\_\_\_\_

\*Source number: The Departments QCP approval number

\*\*Category example: Angles, Channels, Bars, etc.

Xerox additional pages as needed.

FLORIDA DEPARTMENT OF TRANSPORTATION  
MATERIAL SPECIFICATIONS – **COMPLIANCE FORM**

**A completed copy of this page, filled out in ink, must be returned with the bid.** Failure to complete the conformance column may result in a bid being rejected as non-responsive. Unless otherwise stated this data applies to all sites.

REQUIREMENTS	CONFORMANCE
<p>1) The <b>Sheet and Plate</b> materials to be delivered to the <b>Lake City Sign Shop</b> shall meet the requirements of ASTM H-38Alloy 5052. The sheets shall be degreased, etched, and alodized using 12 Alodine. The sheets shall be flat (no coil stock). The edges shall be straight and parallel, and free from damage, ie, nicks, gouges, cracks, etc. (See substitute note on some items).</p>	<p>1) Yes ____ No ____ Alloy _____</p>
<p>2) The <b>Sheet and Plate</b> materials to be delivered to the <b>Oviedo Structural Shop</b> shall meet the requirements of ASTM -209, Alloy 6061-T6 or the Alloy 5052-H32 and the sheets shall <u>not</u> be etched or alodized. Otherwise, the provisions stated in 1) above applies.</p>	<p>2) Yes ____ No ____ Alloy _____</p>
<p>3) The <b>Extruded Tubing</b> shall meet the requirements of ASTM B-221, Alloy 6061-T6. (See substitute note on some items).</p>	<p>3) Yes ____ No ____</p>
<p>4) The <b>Round Bars</b> shall meet the requirements of ASTM B-211, Alloy 6061-T6.</p>	<p>4) Yes ____ No ____</p>
<p>5) The <b>Pipes</b> shall meet the requirements of ASTM B-241, Alloy 6061-T6.</p>	<p>5) Yes ____ No ____</p>
<p>6) The <b>Structural Shapes</b> shall meet the requirements of ASTM B-308, Alloy 6061-T6. (See substitute note on some items).</p>	<p>6) Yes ____ No ____</p>
<p>7) <b>There shall be no paper or other materials used between or on the sheets, tubing, etc.</b></p>	<p>7) Yes ____ No ____</p>
<p>Tolerances for the above materials shall be within the ASTM specification's limits governing each item.</p>	
<p>The ASTM Standard Specification or Tentative Standard Specification in force on the date of the advertisement of the proposal applies, except where a superseded specification, designation, or method is specifically designated.</p>	
<p>The producer shall furnish, at time of delivery, six (6) certified copies of the mill analysis covering the shipment for each size and type of material.</p>	
<p>Upon delivery, random samples of each item will be tested. Should a sample fail to meet the specifications, the entire lot must be replaced within ten (10) days after notification. Replacement of all materials found defective shall be made without cost to the purchaser, including transportation. At the option of the "DOT", the material may be accepted on the basis of the producer's certified mill analysis.</p>	

Signature: \_\_\_\_\_

Name (Print): \_\_\_\_\_

Title: \_\_\_\_\_

Date: \_\_\_\_\_

EXHIBIT "A"

TABLE 26--ZEE SECTIONS\*

\* Areas and section properties listed are based on nominal dimensions. Weights per foot are based on nominal dimensions and a density of 0.098 pounds per cubic inch, the density of Alloy 6061. See ALUMINUM STANDARDS AND DATA for applicable tolerances.

Users are encouraged to ascertain current availability of particular structural shapes through inquires to their suppliers.

Size		Weight b in.	Thick- ness t in.	Area in. <sup>2</sup>	Actual Depth			Axis X - X			Axis Y - Y			Axis Z - Z		
Nominal Depth in	Weight lb/ft				d in.	r <sub>1</sub> in	r <sub>2</sub> in.	I in. <sup>4</sup>	S in. <sup>3</sup>	r in.	I in. <sup>4</sup>	S in. <sup>3</sup>	r in.	α	I in. <sup>4</sup>	r in.
1¼	1.08	1¼	3/16	0.92	1¼	3/16	—	0.446	0.510	0.695	0.551	0.333	0.773	49°□48	0.101	0.331
2	0.92	1¼	3/16	0.78	2	3/16	—	0.458	0.458	0.765	0.186	0.161	0.488	12°□29	0.063	0.283
2 <sub>-</sub>	1.00	1¼	3/16	0.85	2 <sub>-</sub>	3/16	—	0.694	0.584	0.902	0.186	0.161	0.467	12°□23	0.082	0.310
3	2.33	2 <sup>11</sup> / <sub>16</sub>	¼	1.98	3	5/16	¼	2.89	1.92	1.21	2.64	1.03	1.15	24°□43	0.59	0.54
3	3.38	2 <sup>11</sup> / <sub>16</sub>	—	2.87	3	5/16	¼	3.86	2.57	1.16	3.76	1.50	1.14	31°□44	0.82	0.53
4	2.85	3 <sup>1</sup> / <sub>16</sub>	¼	2.42	4	5/16	¼	6.32	3.16	1.62	4.01	1.36	1.29	47°□36	1.08	0.67
4	3.85	3 <sub>-</sub>	5/16	3.04	4 <sup>1</sup> / <sub>16</sub>	5/16	¼	7.97	3.92	1.62	5.24	1.76	1.31	24°□37	1.39	0.68
4	4.32	3 <sup>3</sup> / <sub>16</sub>	—	3.67	4 <sub>-</sub>	5/16	¼	9.66	4.68	1.62	6.54	2.18	1.33	55°□37	1.72	0.68
4	4.78	3 <sup>1</sup> / <sub>16</sub>	7/16	4.06	4	5/16	¼	9.68	4.84	1.54	6.53	2.30	1.27	50°□37	1.74	0.66
4	6.22	3 <sup>3</sup> / <sub>16</sub>	9/16	5.29	4 <sub>-</sub>	5/16	¼	12.76	6.19	1.55	9.05	3.11	1.31	41°□38	2.41	0.68
5	4.01	3¼	5/16	3.41	5	5/16	¼	13.41	5.36	1.98	5.94	1.92	1.32	40°□30	1.89	0.74
5	4.84	3 <sup>5</sup> / <sub>16</sub>	—	4.12	5 <sup>1</sup> / <sub>16</sub>	5/16	¼	16.23	6.41	1.99	7.40	2.37	1.34	08°□31	2.33	0.75
5	6.19	3¼	½	5.27	5	5/16	¼	19.23	7.69	1.91	8.82	2.94	1.29	09°□31	2.82	0.73
6	9.72	3 <sub>-</sub>	1 <sup>1</sup> / <sub>16</sub>	8.27	6 <sub>-</sub>	5/16	¼	43.24	14.12	2.29	16.07	4.90	1.39	44°□27	5.70	0.84

D.O.T. COMMODITY NO. 208-517  
ALUMINUM ZEE BAR, 3" X 2 11/16" X 1/4" X 20'  
ALLOY 6061-T6

D.O.T. COMMODITY NO. 208-560  
ALUMINUM ZEE BAR: 1 3/4" X 1 3/4" X 3/16" X 10'  
ALLOY 6061-T6



# ALUMINUM Z-BAR

## FRONT VIEW

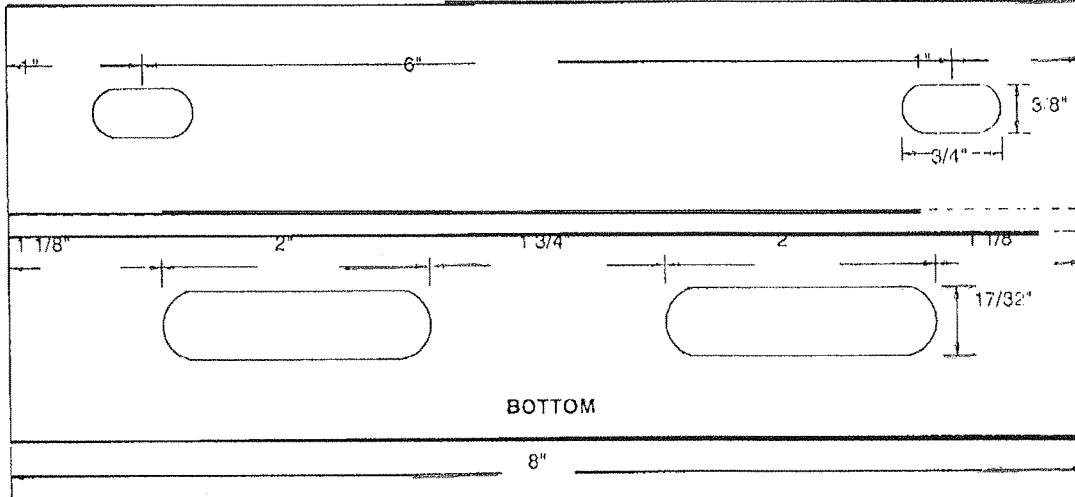

## SIDE VIEW

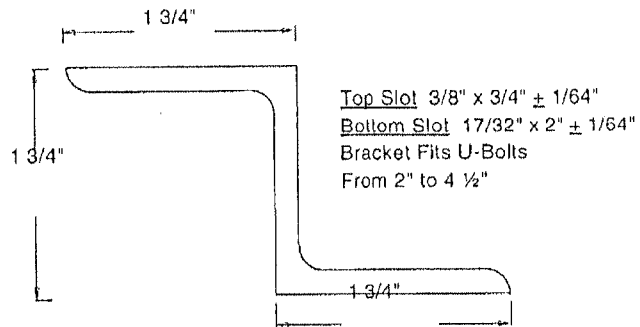

DRAWING #1

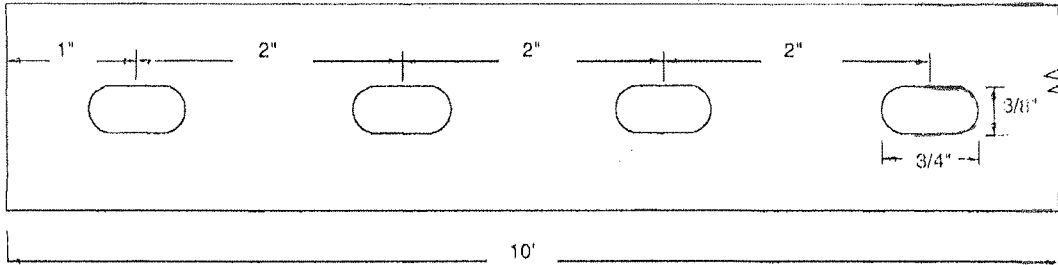

ALUMINUM ZEE BAR (DOT #208-560)  
1 3/4" x 1 3/4" x 3/16" x 10'  
ALLOY 6061-T6  
RECTANGULAR HOLES PUNCHED ON ONE FLANGE  
3/8" x 3/4" ON 2" CENTERS

DRAWING #2

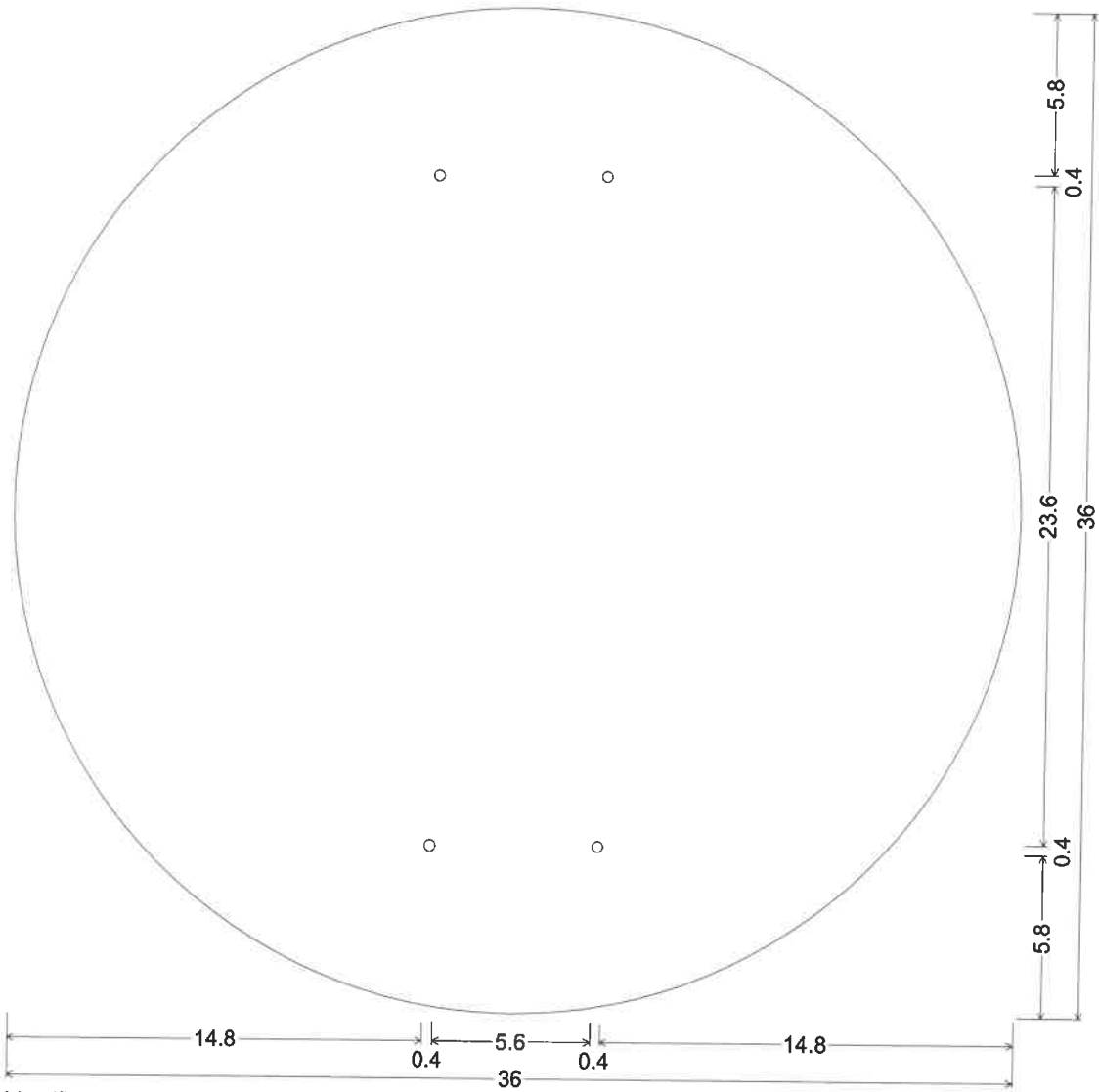

Identifier : DRAWING 3 36 INCH ROUND;  
No border, None;

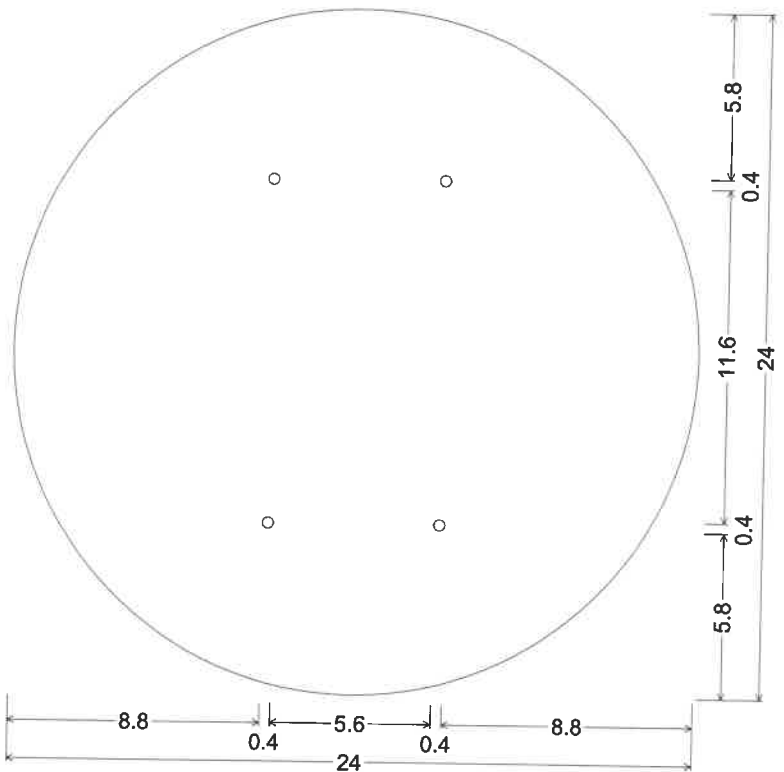

Identifier : drawing 3a 24" ROUND;  
 No border, None;

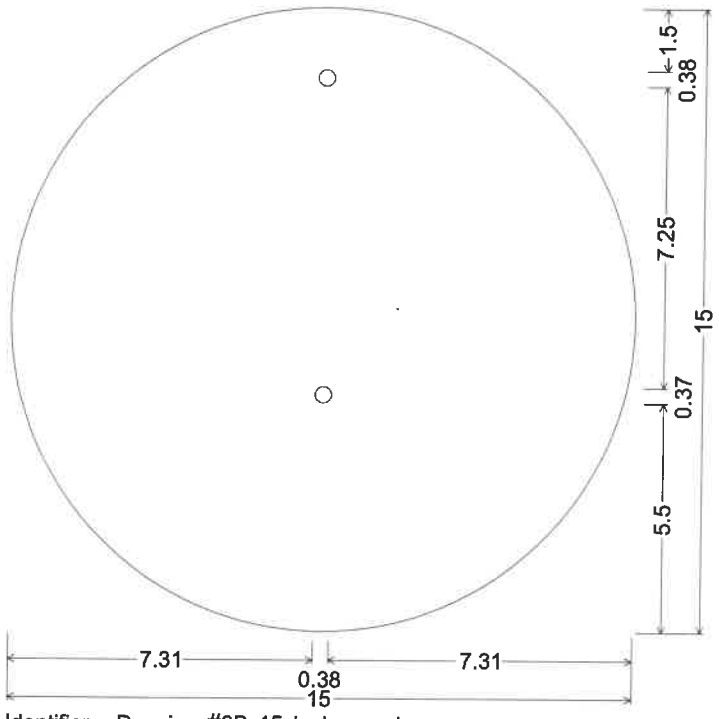

Identifier : Drawing #3B 15 inch round;  
 No border, None;

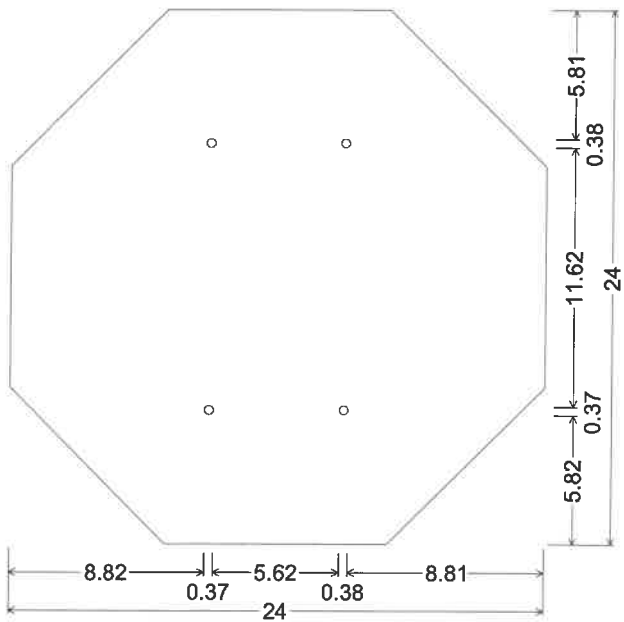

Identifier : DRAWING 4 24 INCH OCTAGON;  
 No border, None;

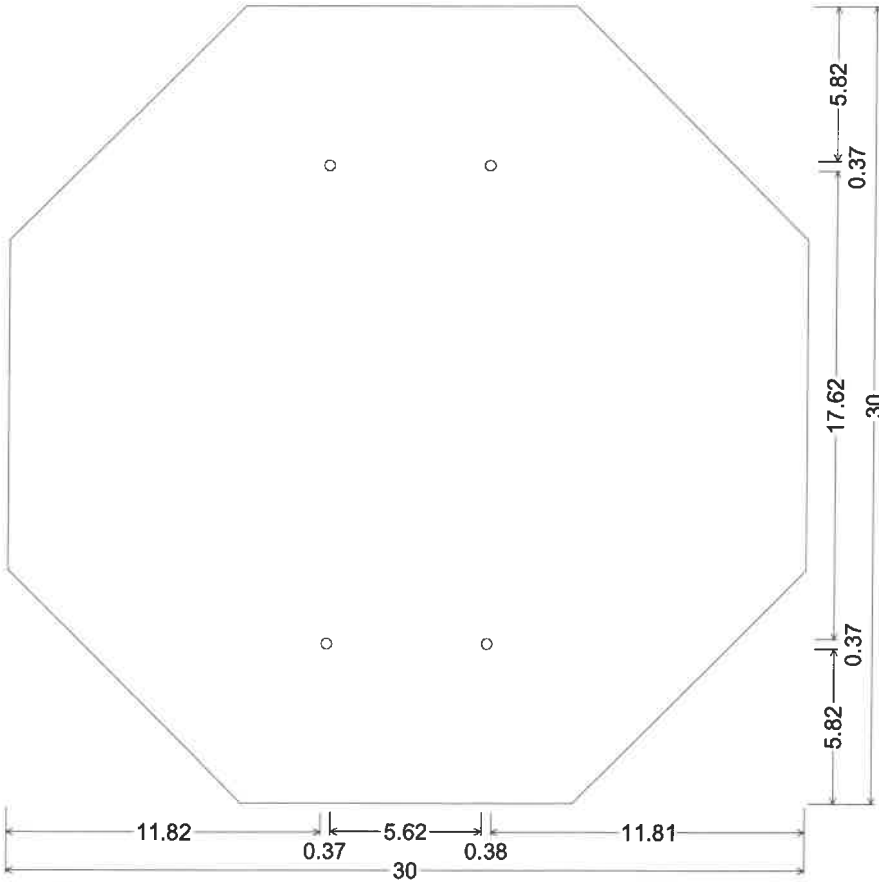

Identifier : DRAWING 5 30 INCH OCTAGON;  
 No border, None;

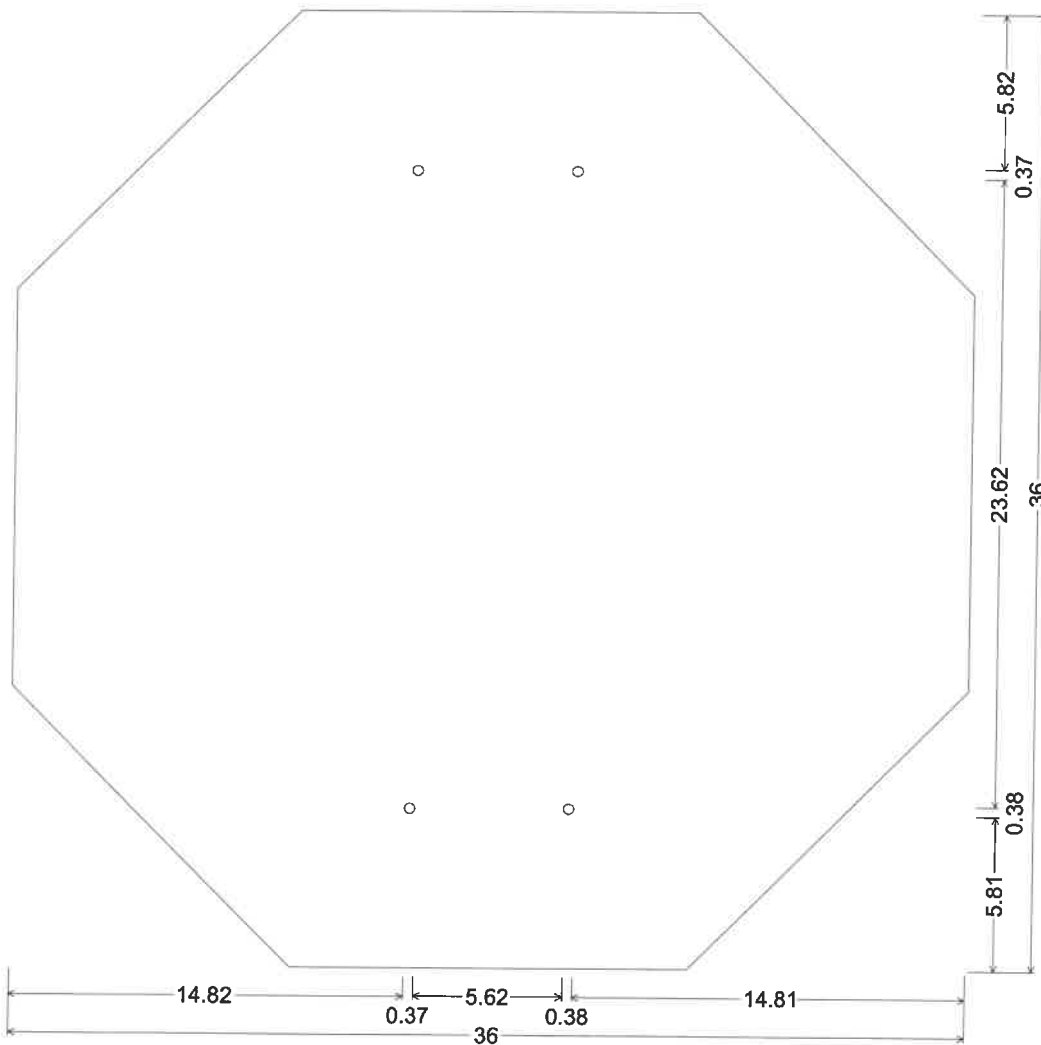

Identifier : DRAWING 6 36 INCH OCTAGON;  
 No border, None;



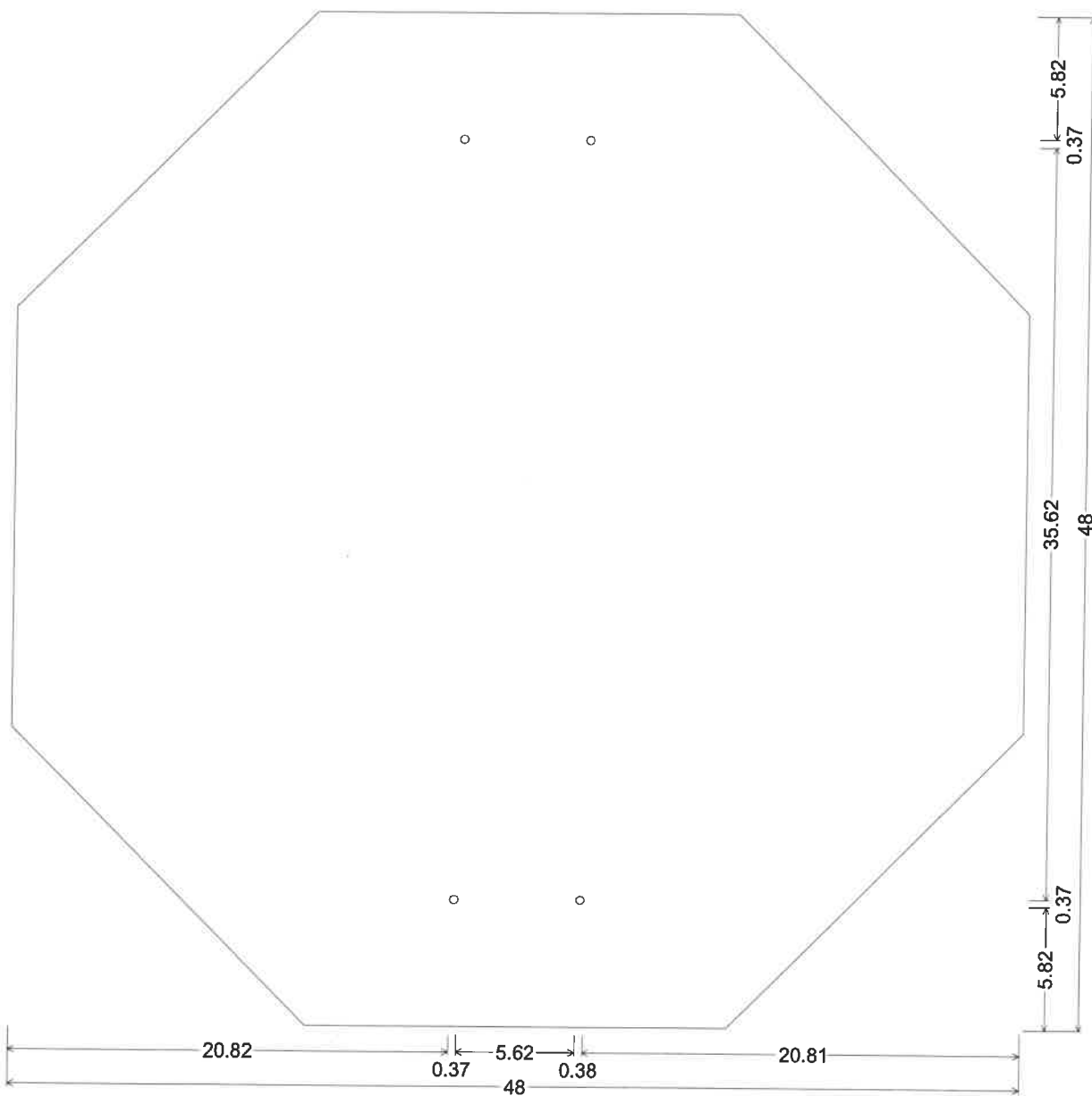

Identifier : DRAWING 6A 48 INCH OCTAGON;  
 No border, None;

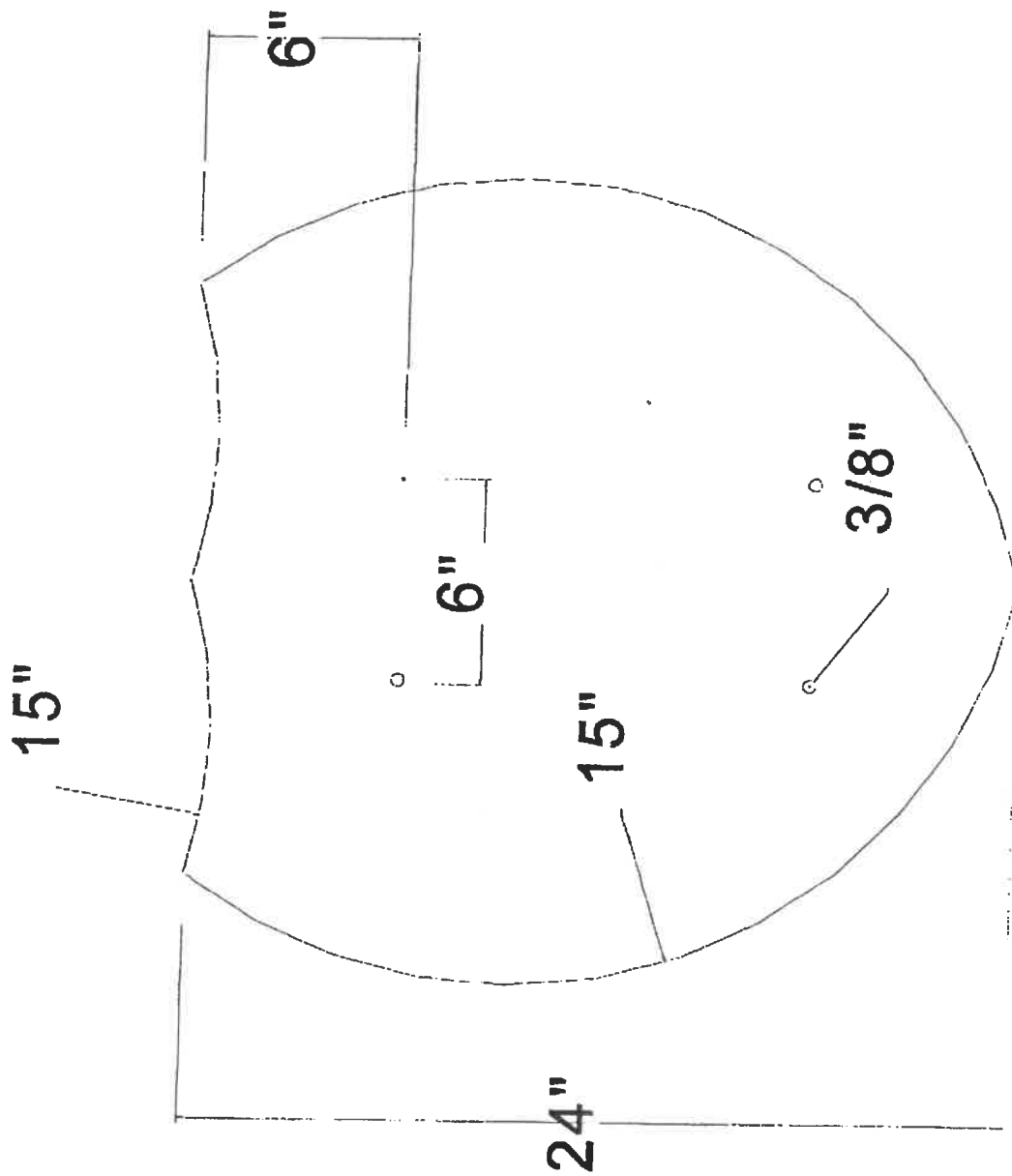

DRAWING # 7

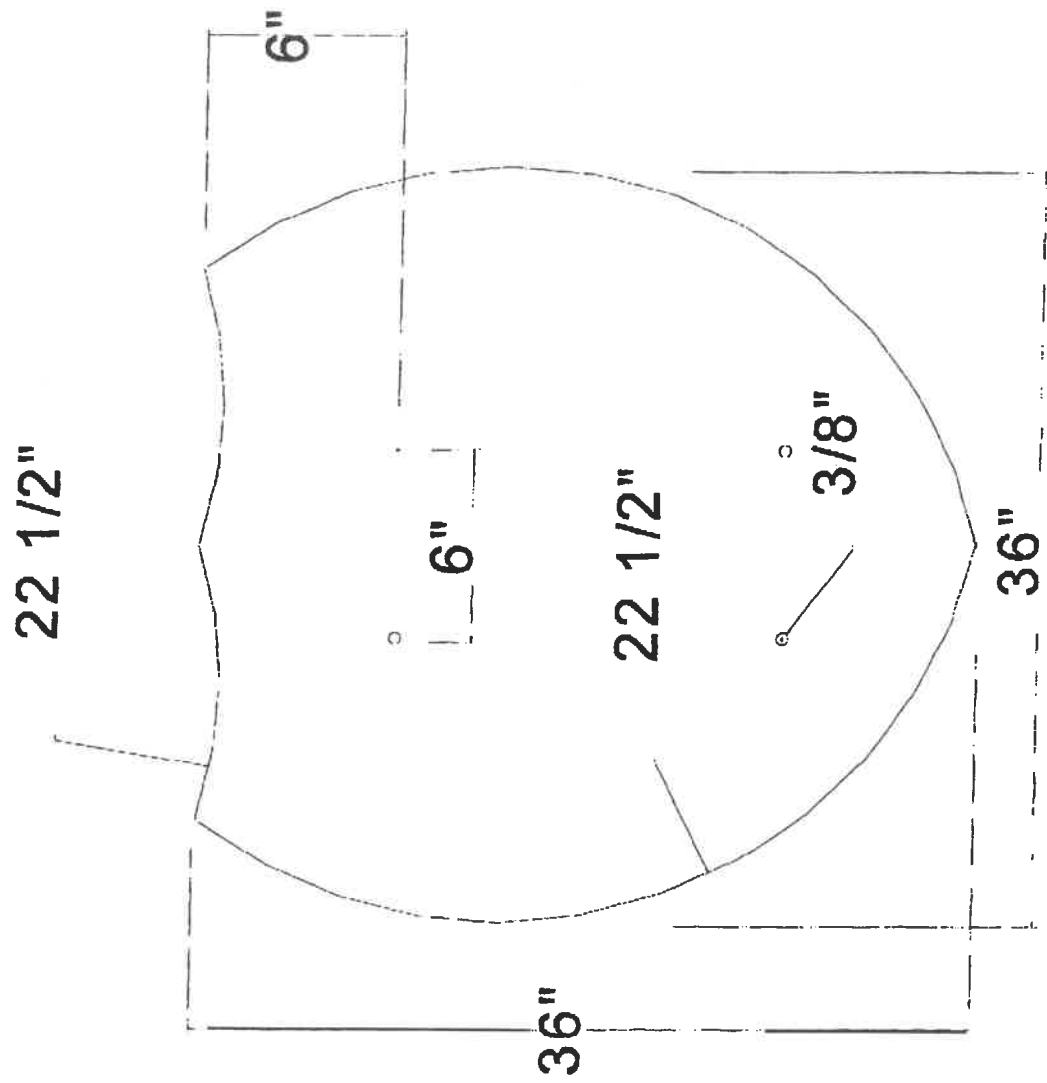

DRAWING # 7a

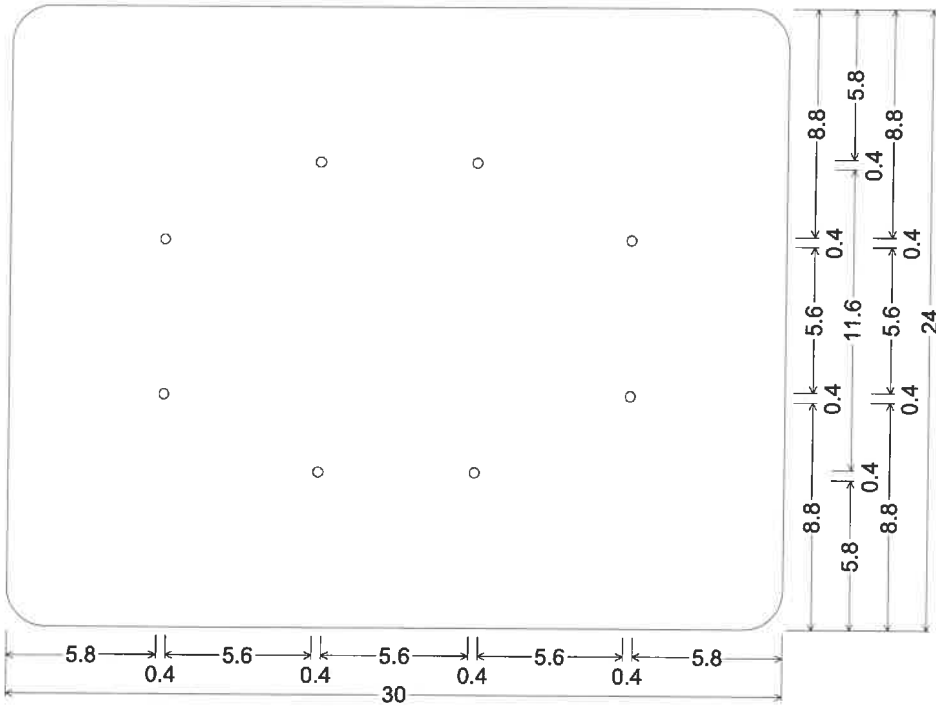

Identifier : DRAWING 8 24"X30" RECTANGLE;

1.5" Radius, No border, White on None;

Table of widths and spaces.

5.8	○	0.4	5.6	○	0.4	5.6	○	0.4	5.6	○	0.4	5.8
5.8	○	0.4	5.6	○	0.4	5.6	○	0.4	5.6	○	0.4	5.8

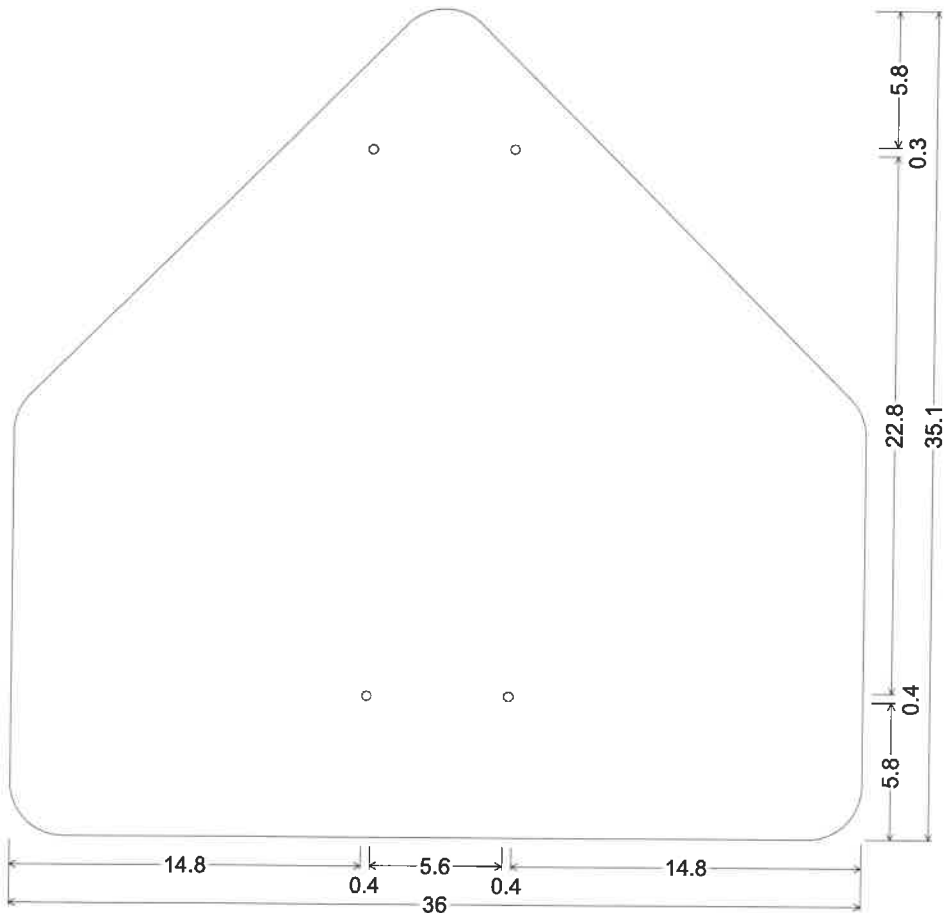

Identifier : DRAWING 9 36 INCH PENTAGON;  
 36.0" base to corner 2.3" Radius, No border, None;  
 Table of widths and spaces.

	○		○	
14.8	0.4	5.6	0.4	14.8
	○		○	
14.8	0.4	5.6	0.4	14.8

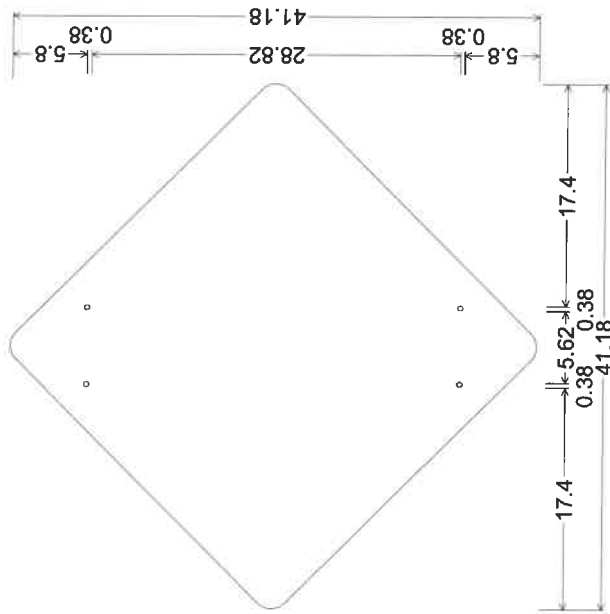

Identifier : DRAWING 10 30X30 ON DIAMOND;  
 30.00" across sides 1.50" Radius, No border, None;  
 Table of widths and spaces.

○	○	○	○
17.40	0.38	5.62	0.38
17.40	0.38	5.62	0.38

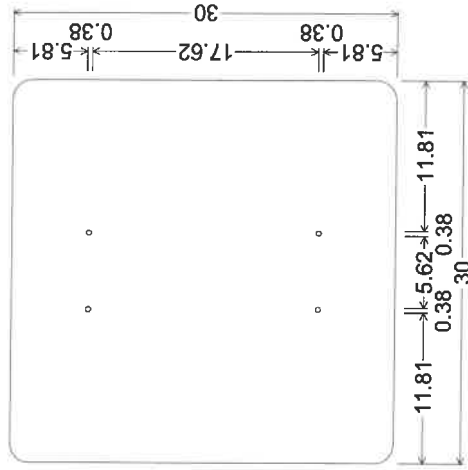

Identifier : DRAWING 11 GOES WITH DRAWING 10 30X30 SQUARE;  
 1.50" Radius, No border, White on None;  
 Table of widths and spaces.

○	○	○	○
11.81	0.38	5.62	0.38
11.81	0.38	5.62	0.38

Note: Both holes in the drawings will  
 will be made in this blank.

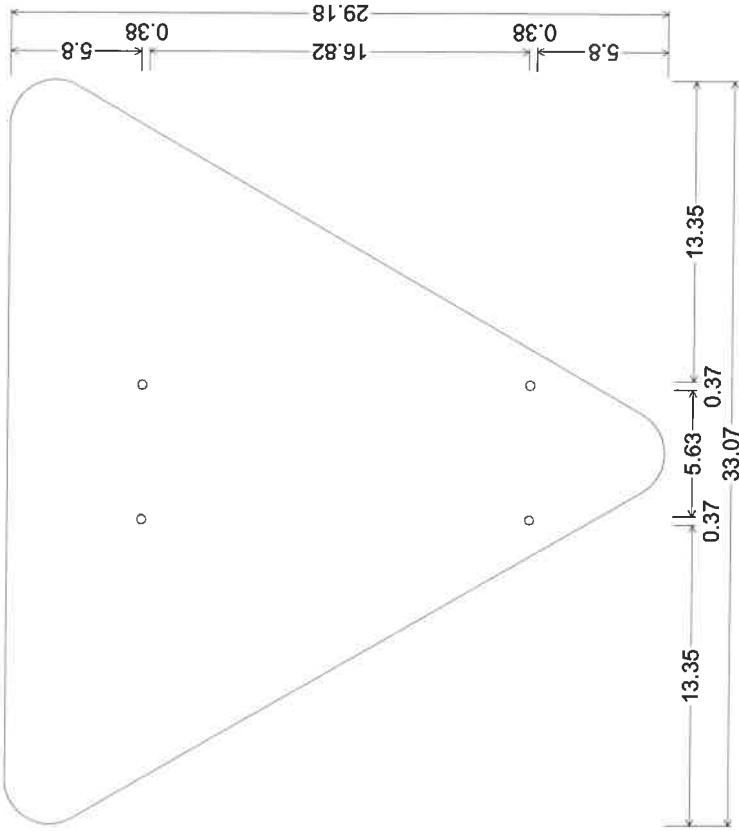

Identifier : DRAWING 12A 36 INCH TRIANGLE;  
 36.00" corner to corner 2.00" Radius, No border, None;  
 Table of widths and spaces.

13.35	0.37	5.63	0.37	13.35
13.35	0.37	5.63	0.37	13.35

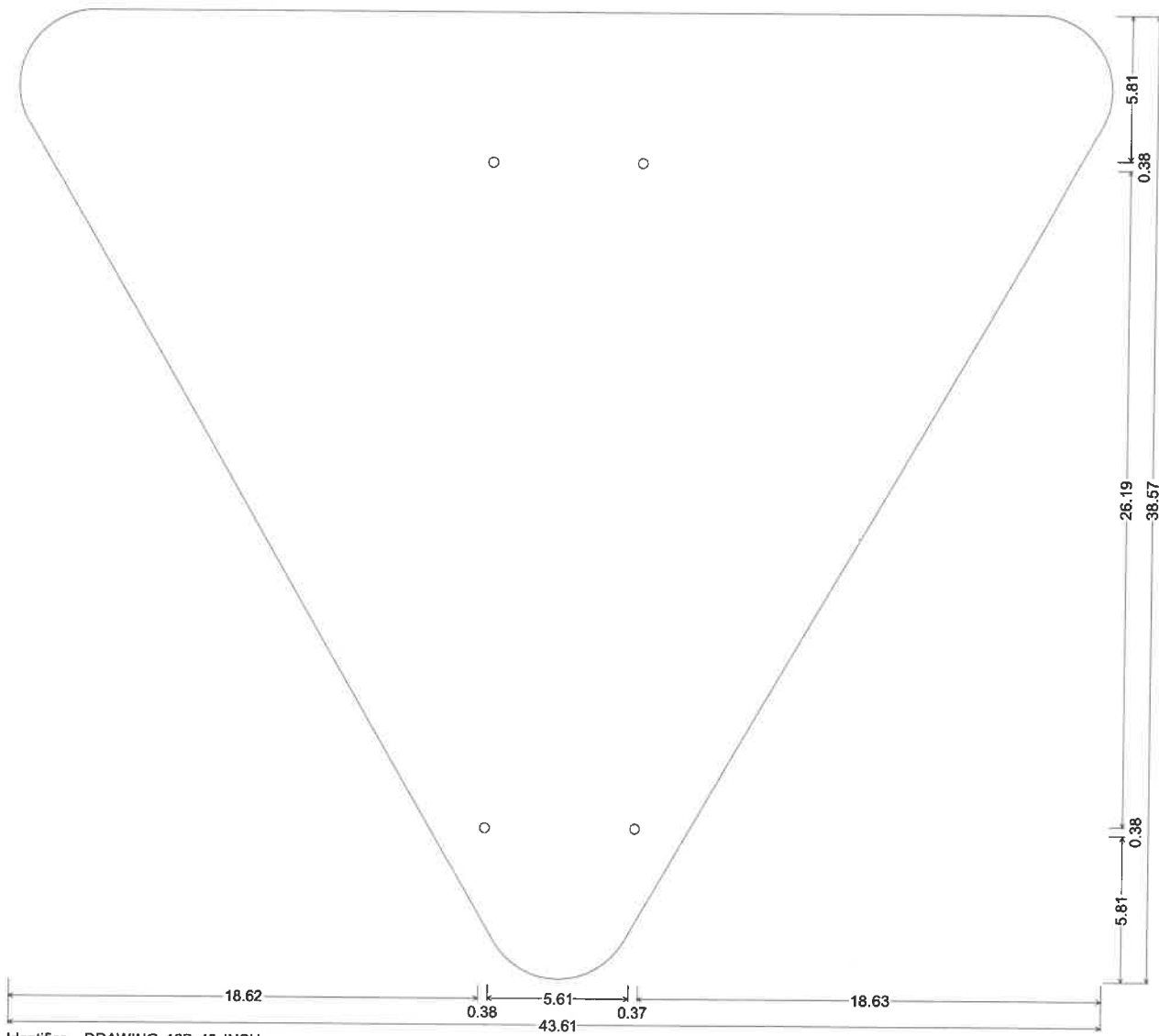

Identifier : DRAWING 12B 48 INCH;  
 48.00" corner to corner 3.00" Radius, No border, None;

Table of widths and spaces.

○	○			
18.62	0.38	5.61	0.37	18.63
○	○			
18.62	0.38	5.61	0.37	18.63



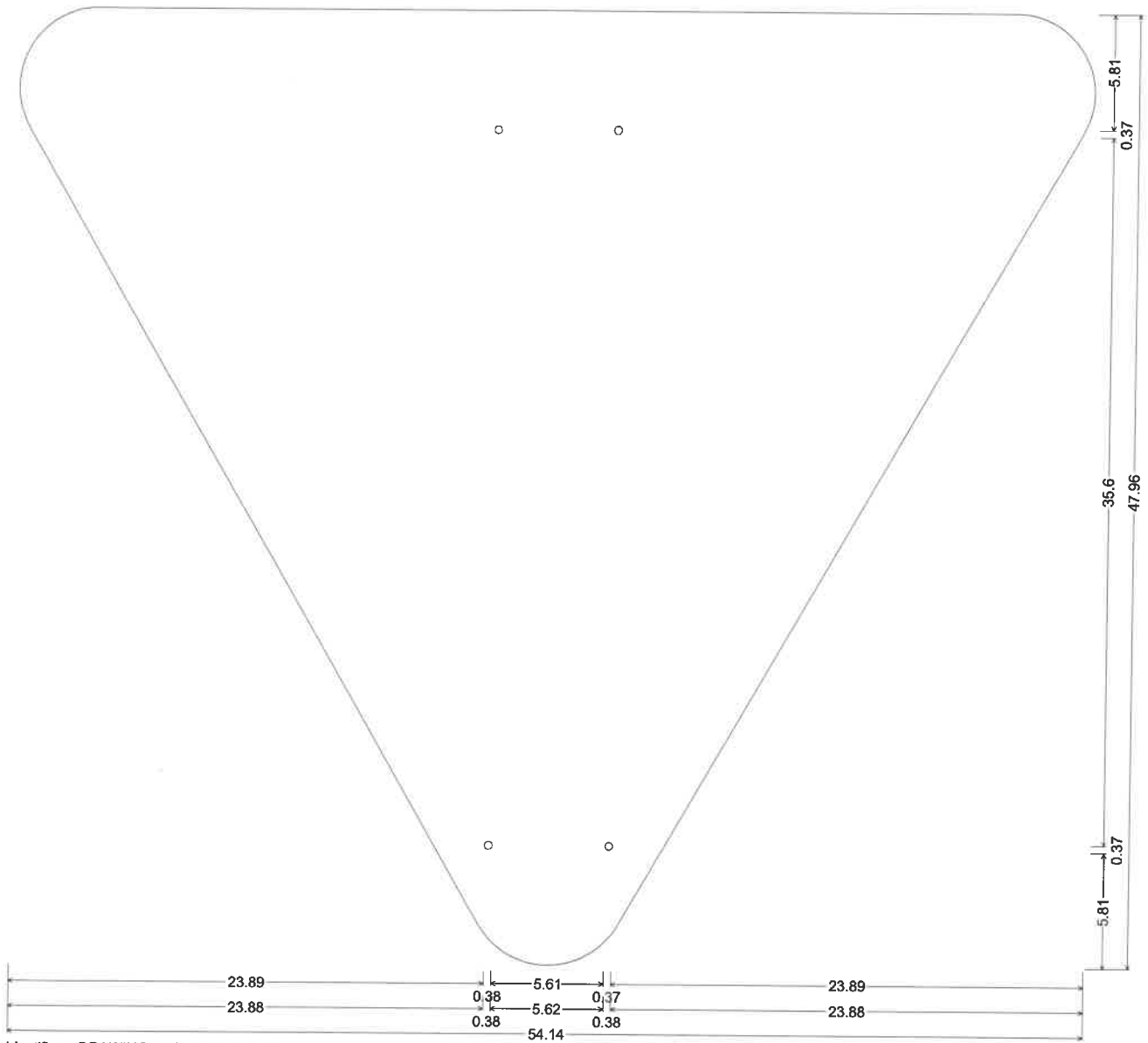

Identifier : DRAWING 12C 60 INCH YIELD;  
 60.00" corner to corner 4.00" Radius, No border, None;  
 Table of widths and spaces.

23.89	○	0.38	5.61	○	0.37	23.89
23.88	○	0.38	5.62	○	0.38	23.88
23.88	○	0.38	5.62	○	0.38	23.88

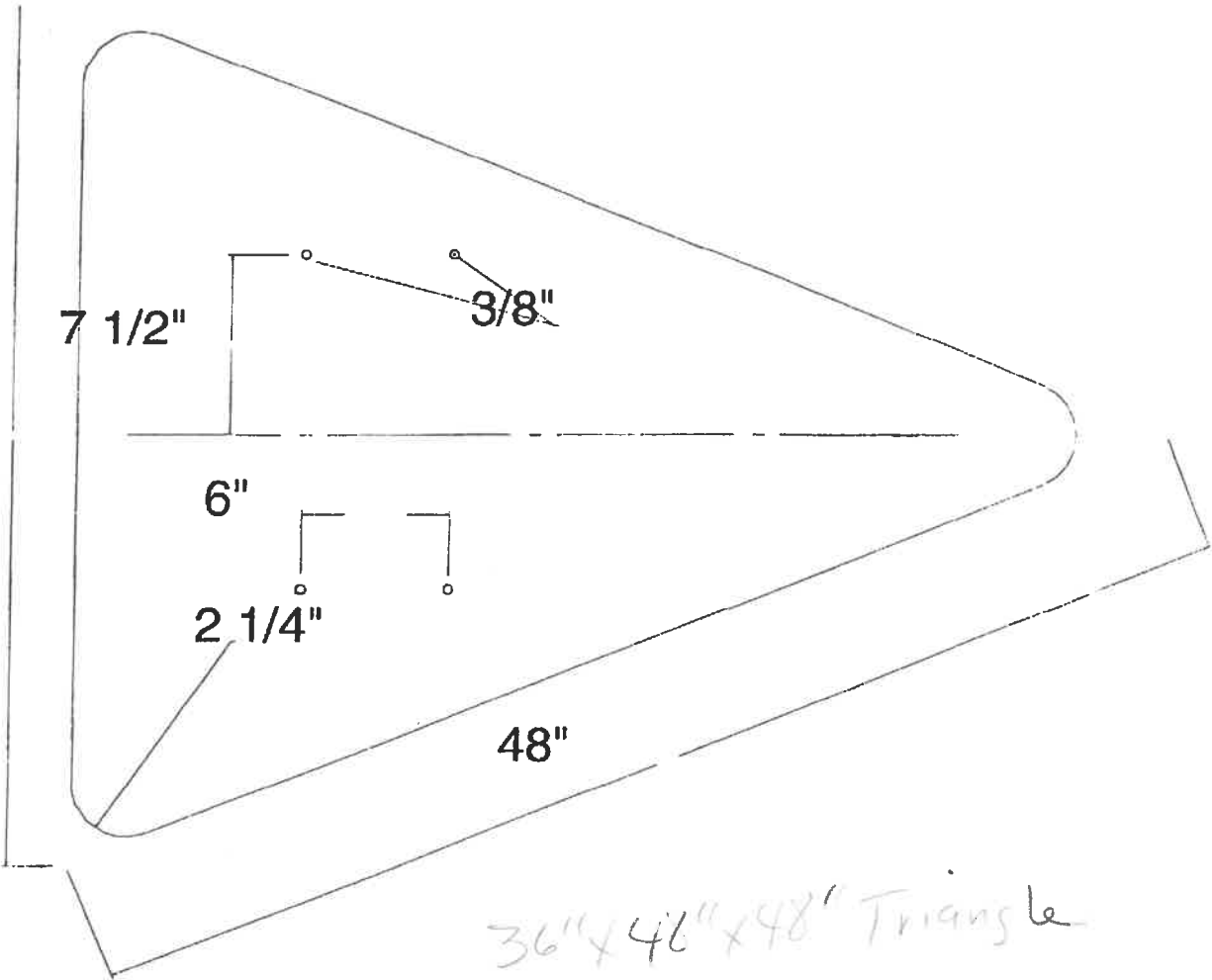

DRAWING #13

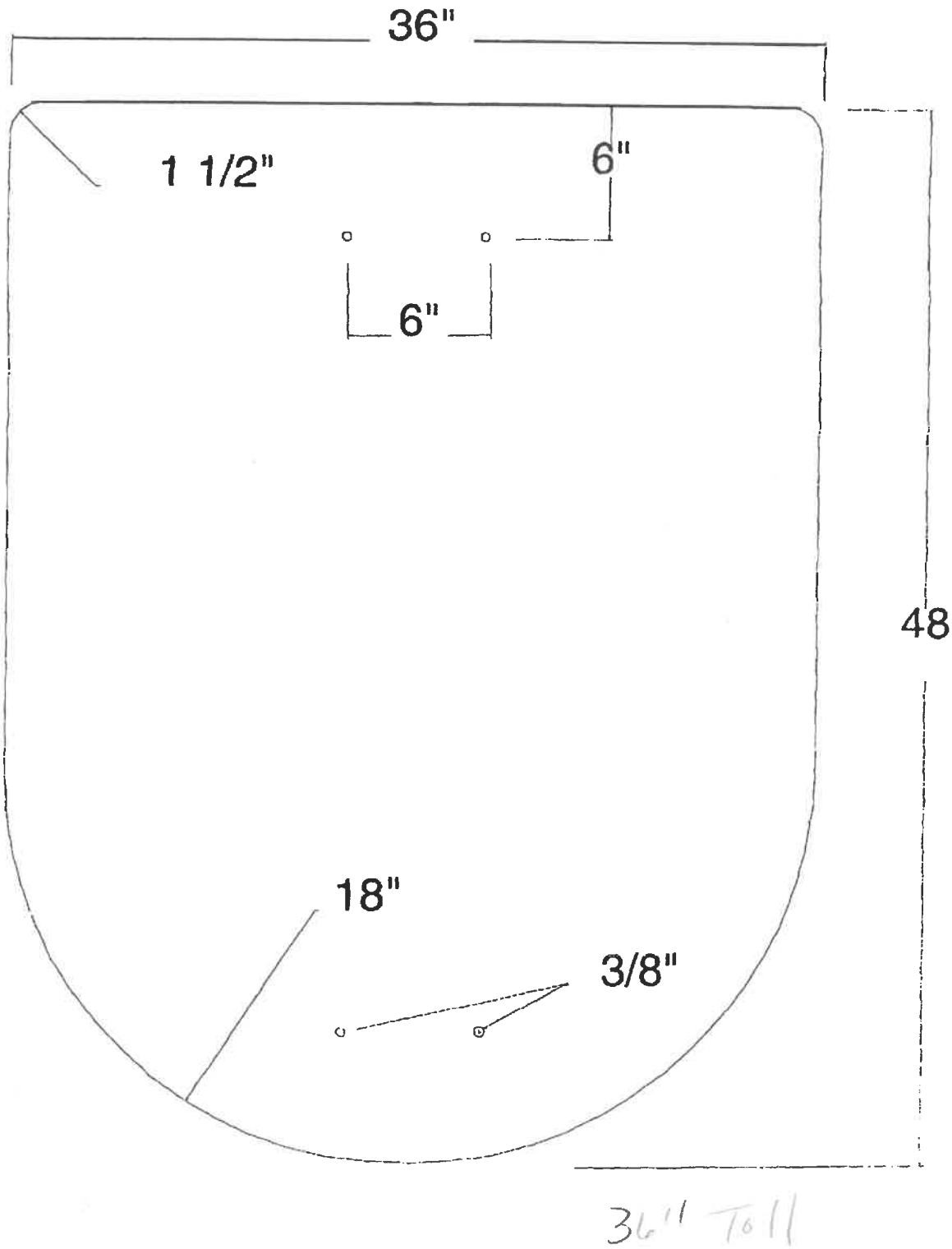

DRAWING #14

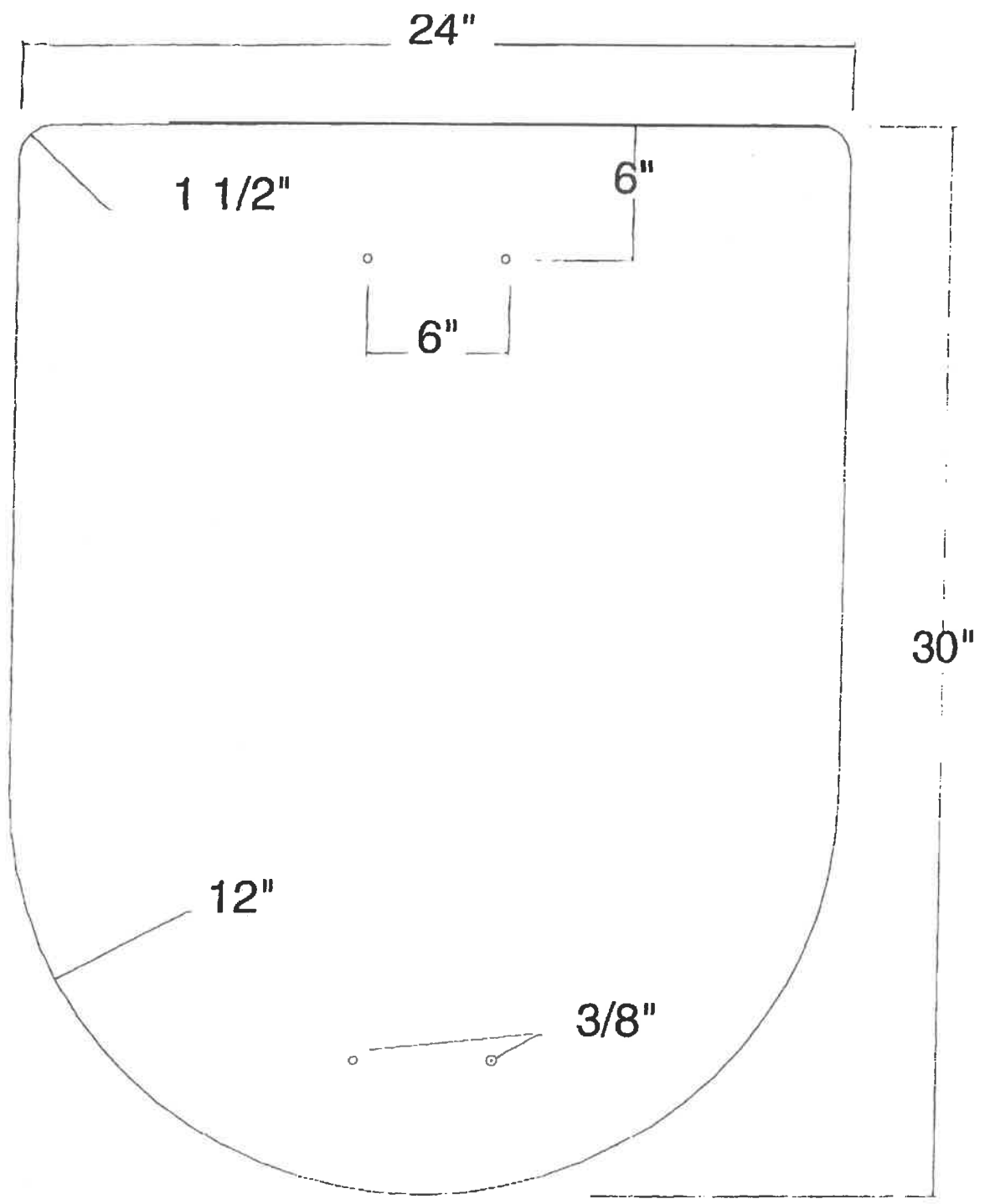

24" Tall

DRAWING #15

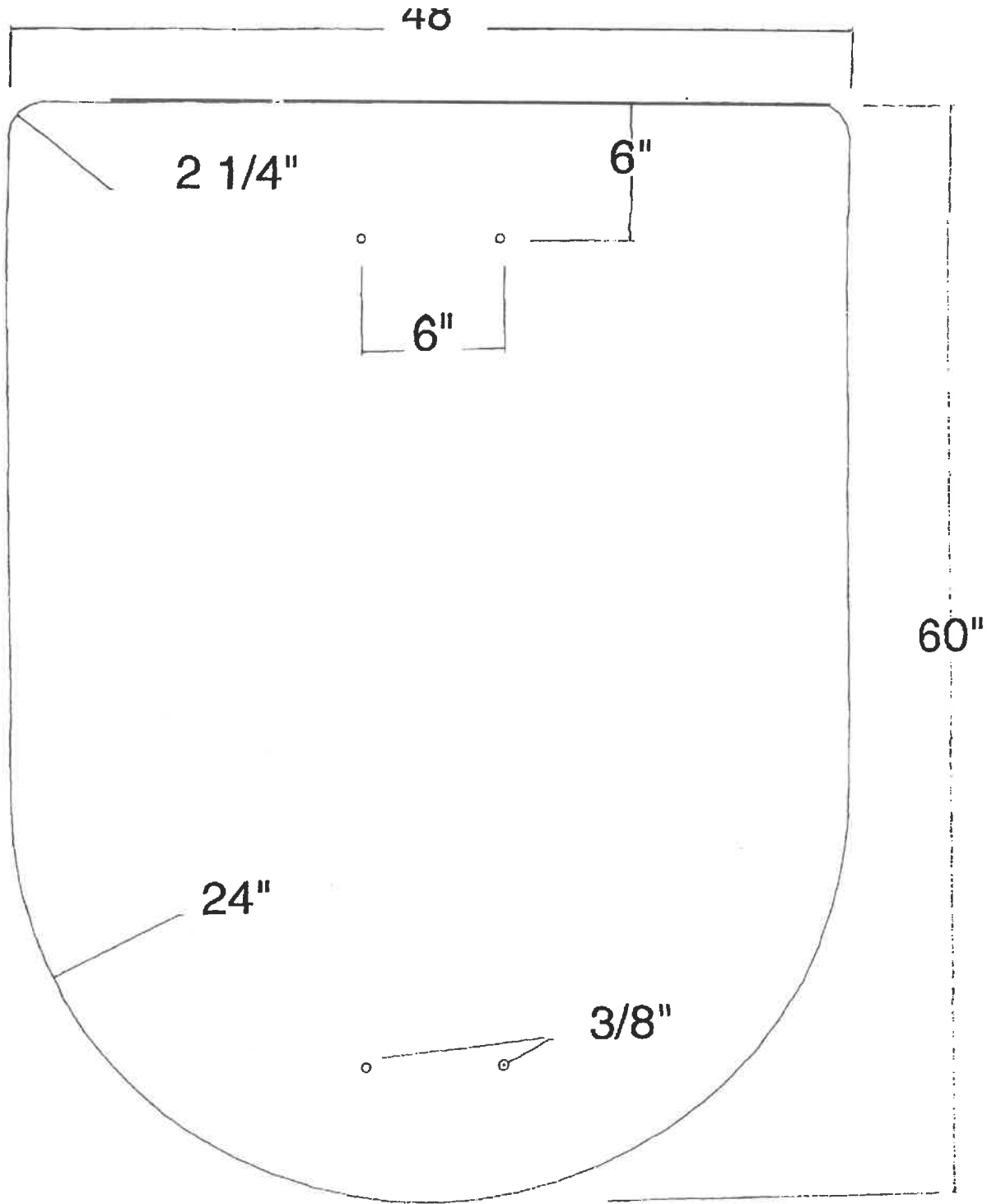

48" Tall

DRAWING # 16

45

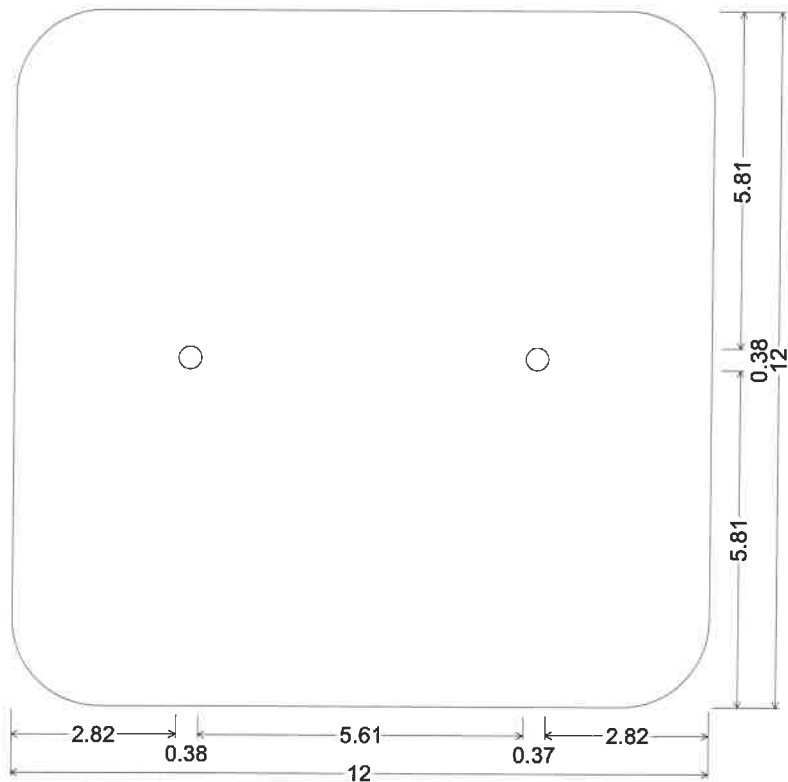

Identifier : DRAWING 17 12X12;  
 1.50" Radius, No border, White on None;  
 Table of widths and spaces.

2.82	○	0.38	5.61	○	0.37	2.82
------	---	------	------	---	------	------

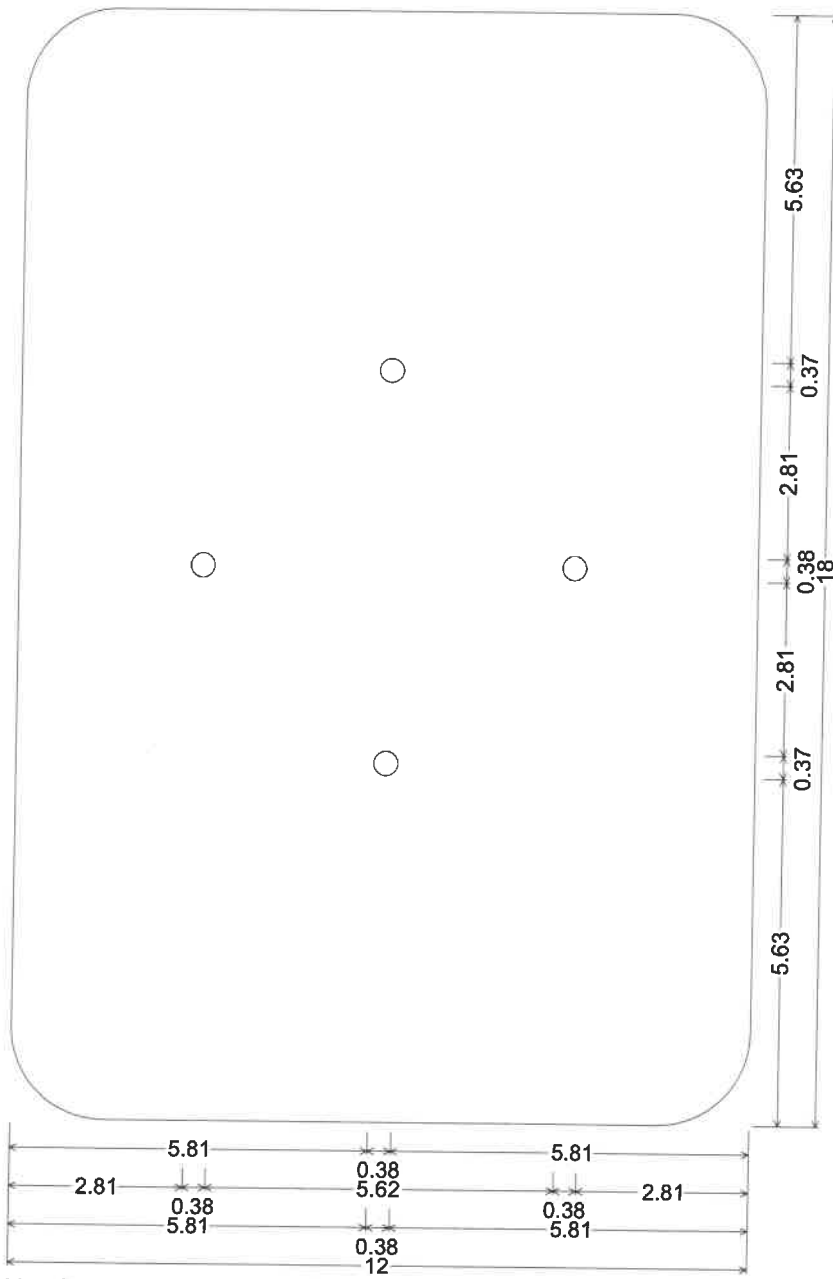

Identifier : Drawing 18 12x18 Rectangle;  
 1.50" Radius, No border, White on None;  
 Table of widths and spaces.

5.81	○	5.81		
2.81	○	5.62	○	2.81
5.81	○	5.81		

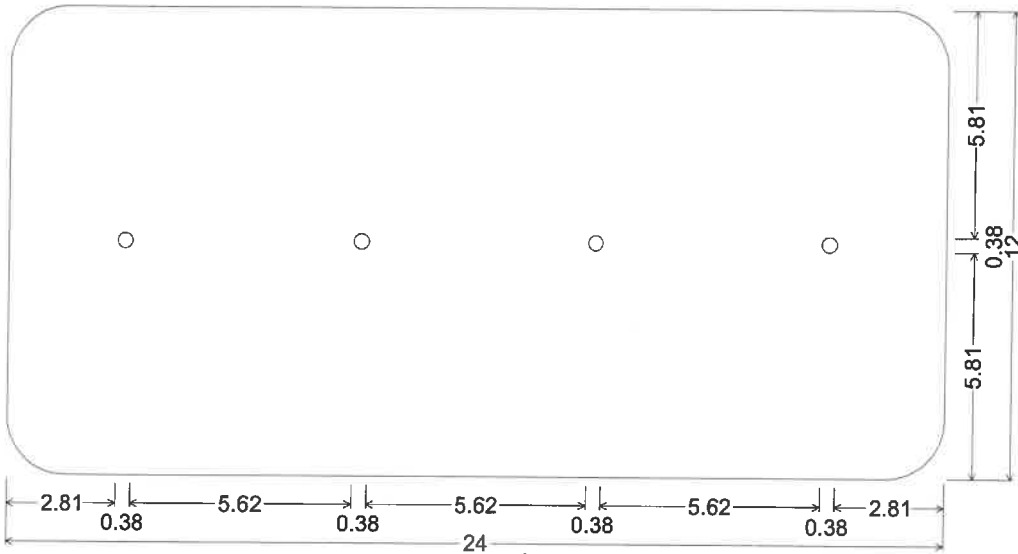

Identifier : DRAWING 19 12 X24;  
 1.50" Radius, No border, White on None;  
 Table of widths and spaces.

*Rectangle*

2.81	○	0.38	○	5.62	○	0.38	○	5.62	○	0.38	5.62	○	0.38	2.81
------	---	------	---	------	---	------	---	------	---	------	------	---	------	------



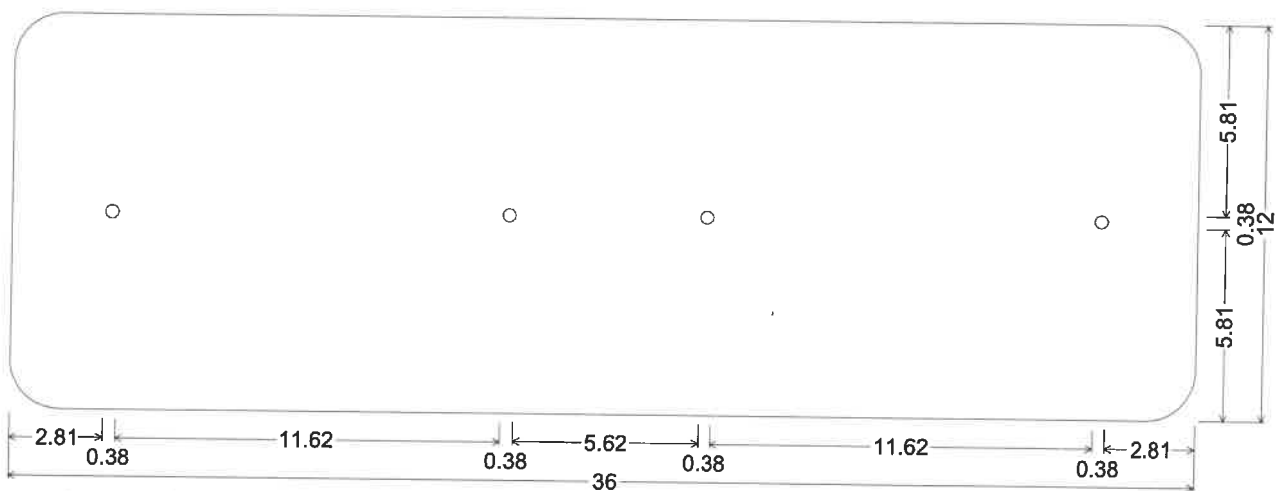

Identifier : DRAWING 20 12X36;  
 1.50" Radius, No border, White on None;  
 Table of widths and spaces.

*Rectangle*

2.81	0.38	11.62	0.38	5.62	0.38	11.62	0.38	2.81
------	------	-------	------	------	------	-------	------	------

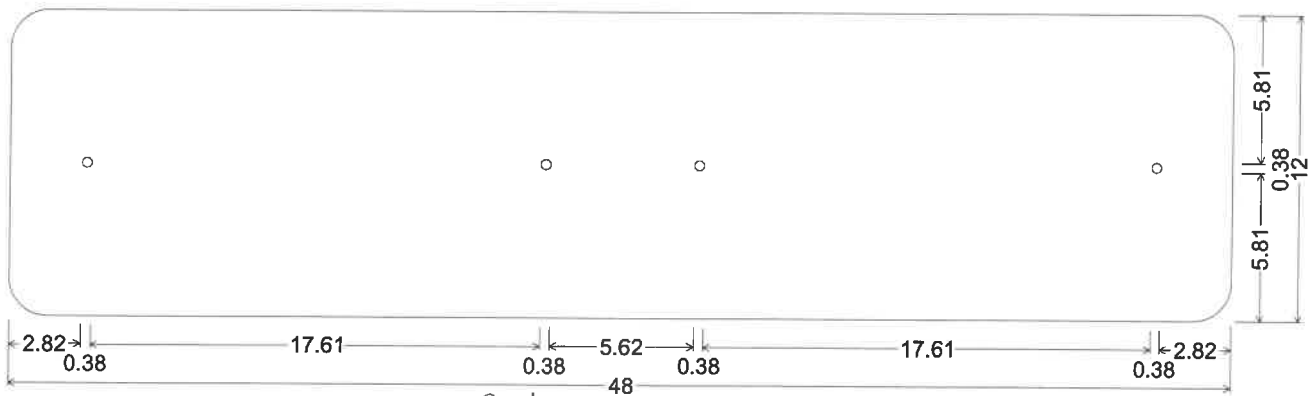

Identifier : DRAWING 21 12X48;  
 1.50" Radius, No border, White on None;  
 Table of widths and spaces.

*Rectangle*

2.82	○	0.38	17.61	○	0.38	5.62	○	0.38	17.61	○	0.38	2.82
------	---	------	-------	---	------	------	---	------	-------	---	------	------

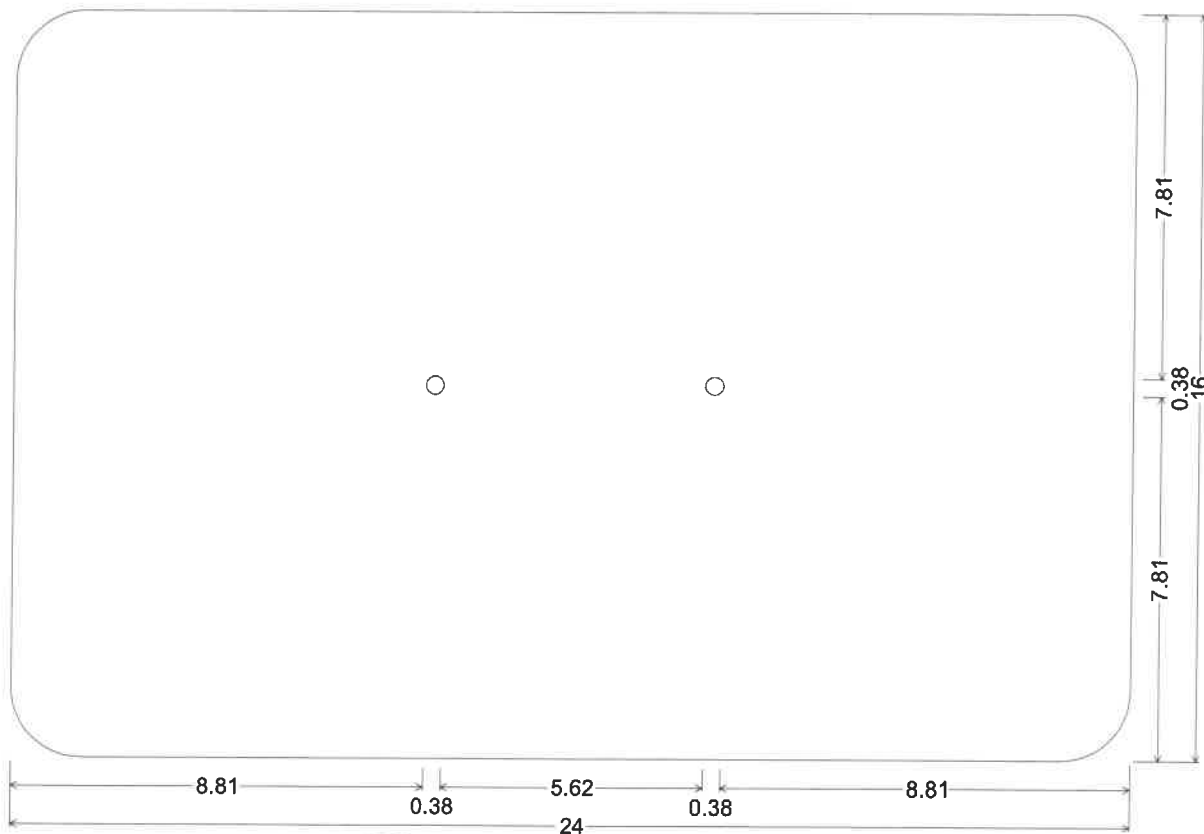

Identifier : DRAWING 22 16"X24",  
 1.50" Radius, No border, White on None;  
 Table of widths and spaces.

*rectangle*

8.81	0.38	5.62	0.38	8.81
------	------	------	------	------

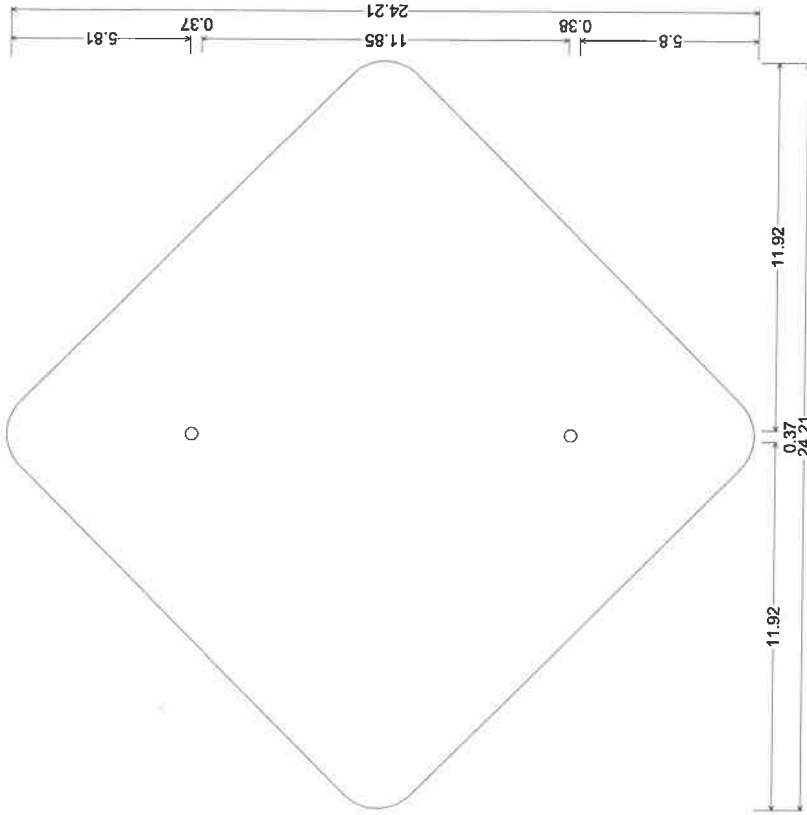

18.00" across sides 1.50" Radius, No border, None;  
Table of widths and spaces.

○	11.92	0.37	11.92
○	11.92	0.37	11.92

Drawing 23a 18" Diamond

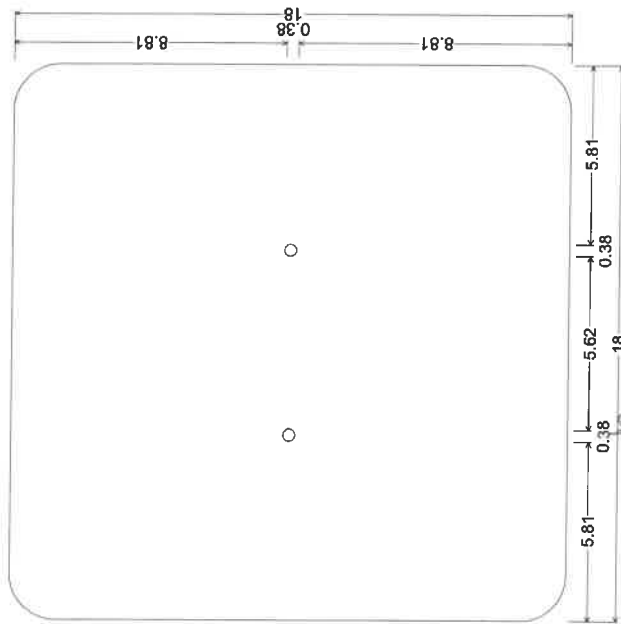

Identifier : DRAWING 23 18 X 18;  
1.50" Radius, No border, White on None;  
Table of widths and spaces.

○	5.81	0.38	5.62	0.38	5.81
○	5.81	0.38	5.62	0.38	5.81

18" Square

Note:  
Both holes in the drawings 23a & 23b  
made in this blank.

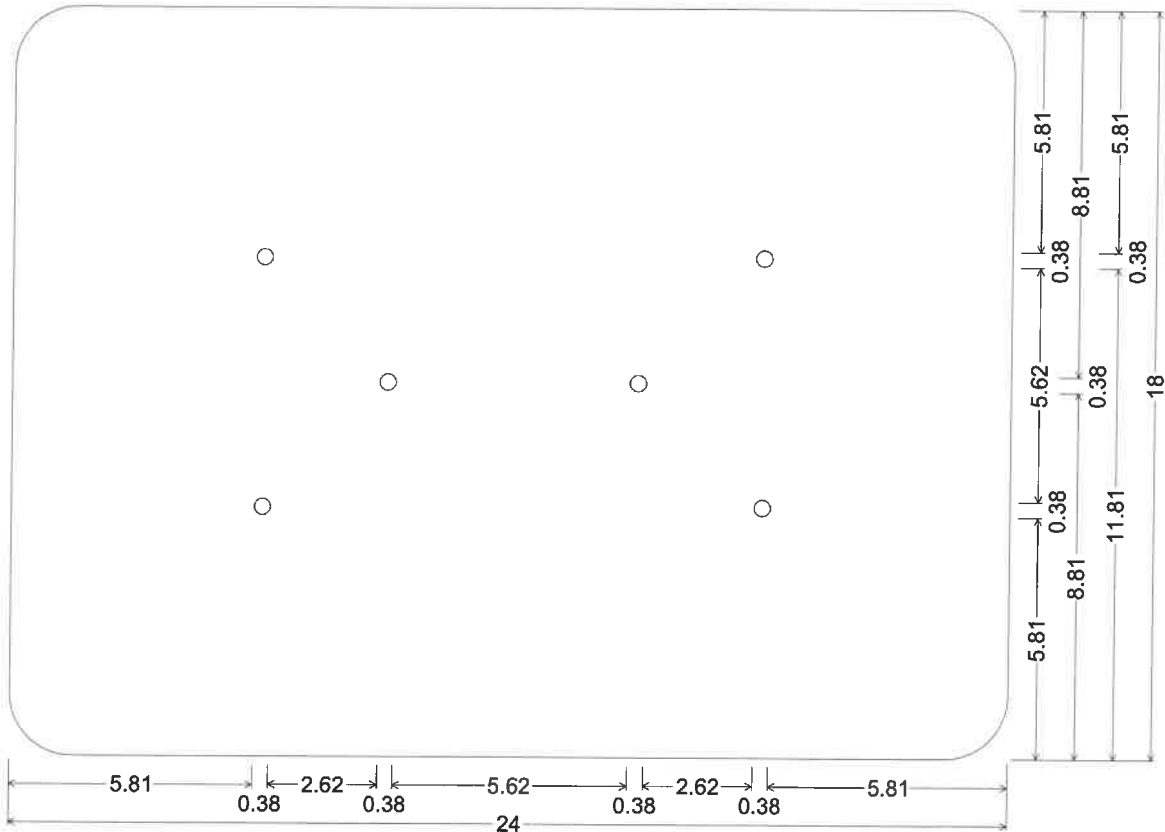

Identifier : DRAWING 24 18X24; *Rectangle*  
 1.50" Radius, No border, White on None;

Table of widths and spaces.

5.81	○	0.38	2.62	○	0.38	5.62	○	0.38	2.62	○	0.38	5.81
5.81	○	0.38	11.62	○	0.38	5.81						

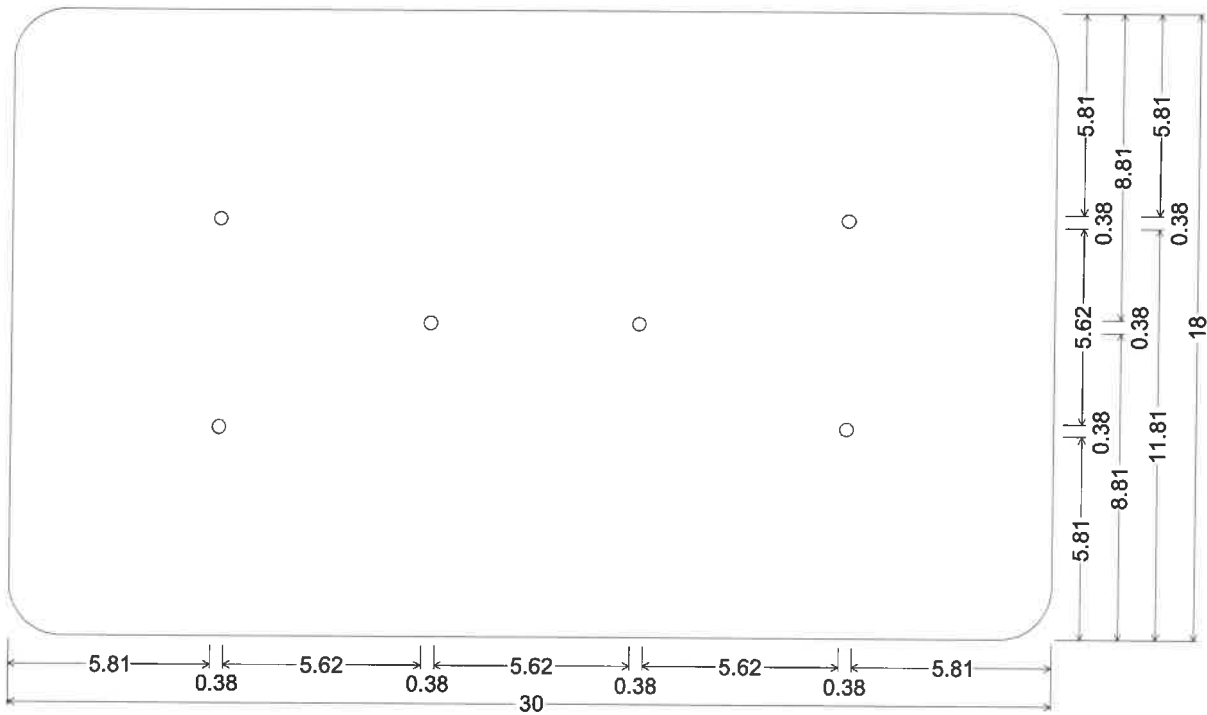

Identifier : DRAWING 25 18X30;  
 1.50" Radius, No border, White on None;  
 Table of widths and spaces.

*re fangle*

5.81	○	0.38	5.62	○	0.38	5.62	○	0.38	5.62	○	0.38	5.81
5.81	○	0.38	17.62	○	0.38	5.81						

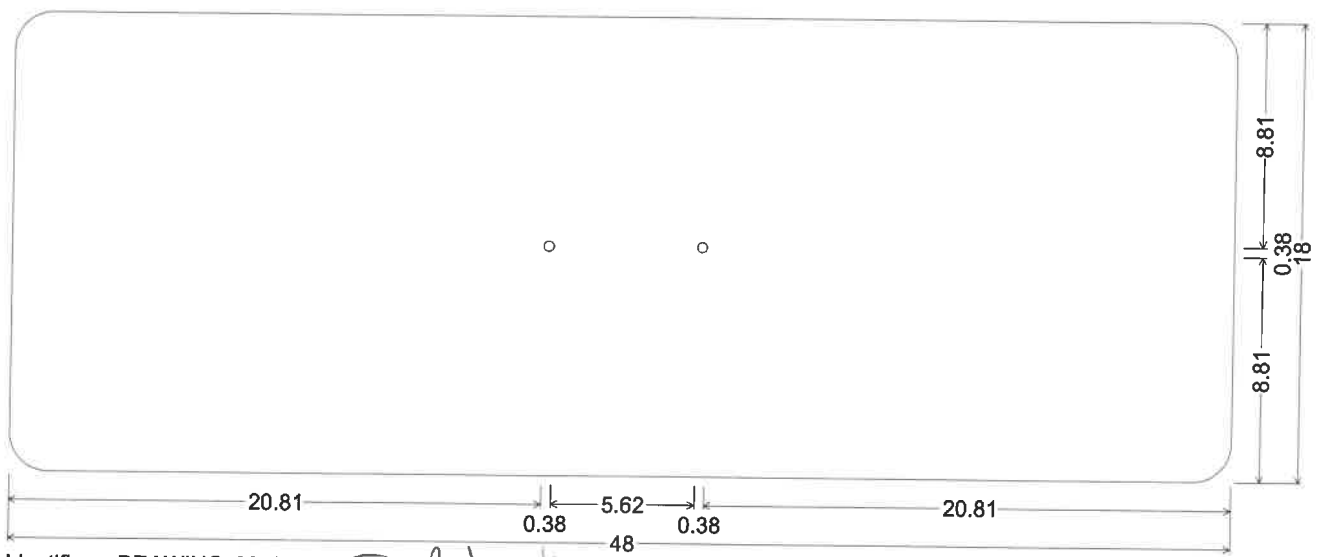

Identifier : DRAWING 26 18X48; *Rectangle*  
 1.50" Radius, No border, White on None;  
 Table of widths and spaces.

20.81	○	0.38	5.62	○	0.38	20.81
-------	---	------	------	---	------	-------

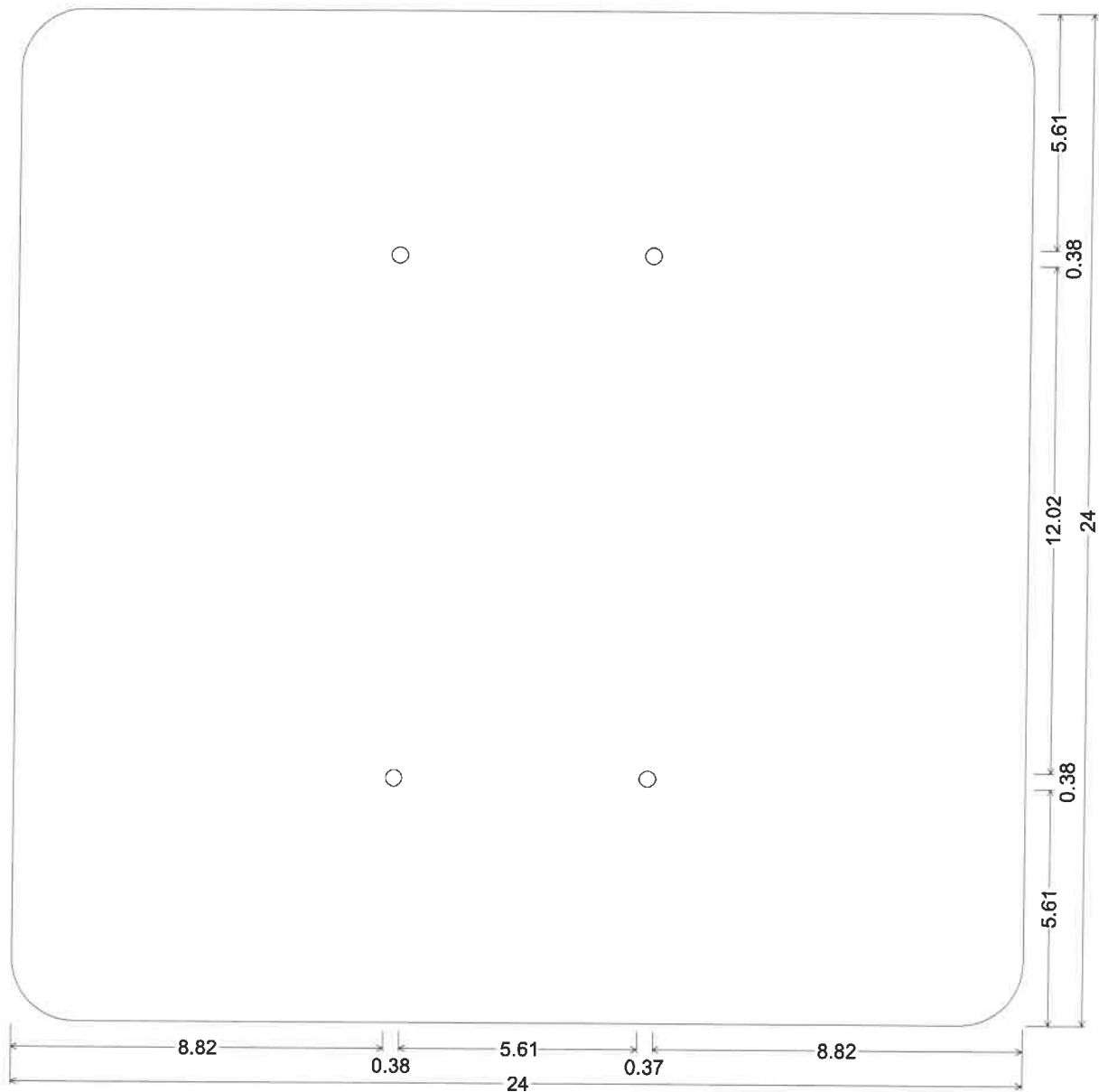

Identifier : DRAWING 27 24X24;  
 1.50" Radius, No border, White on None;  
 Table of widths and spaces.

	○		○	
8.82	0.38	5.61	0.37	8.82
	○		○	
8.82	0.38	5.61	0.37	8.82



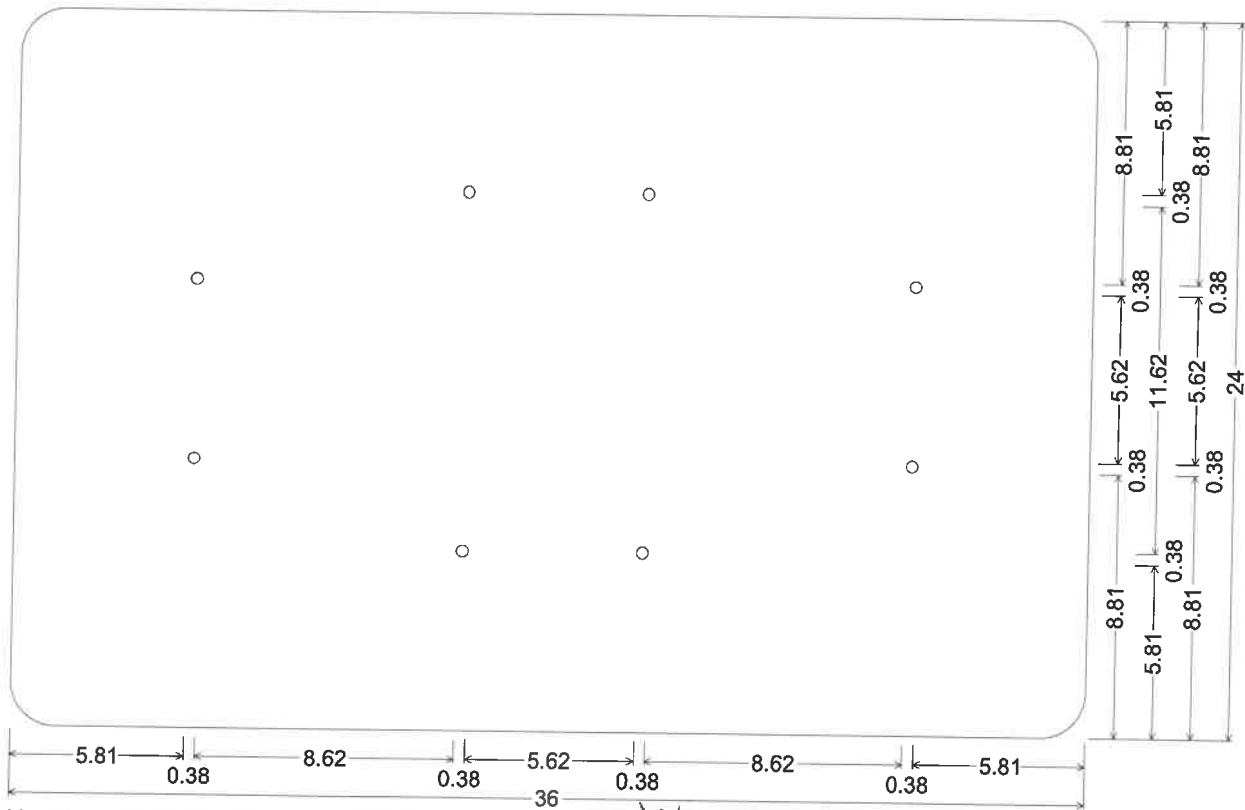

Identifier : DRAWING 28 24X36;  
 1.50" Radius, No border, White on None;  
 Table of widths and spaces.

*rectangle*

5.81	0.38	8.62	0.38	5.62	0.38	8.62	0.38	5.81
5.81	0.38	8.62	0.38	5.62	0.38	8.62	0.38	5.81

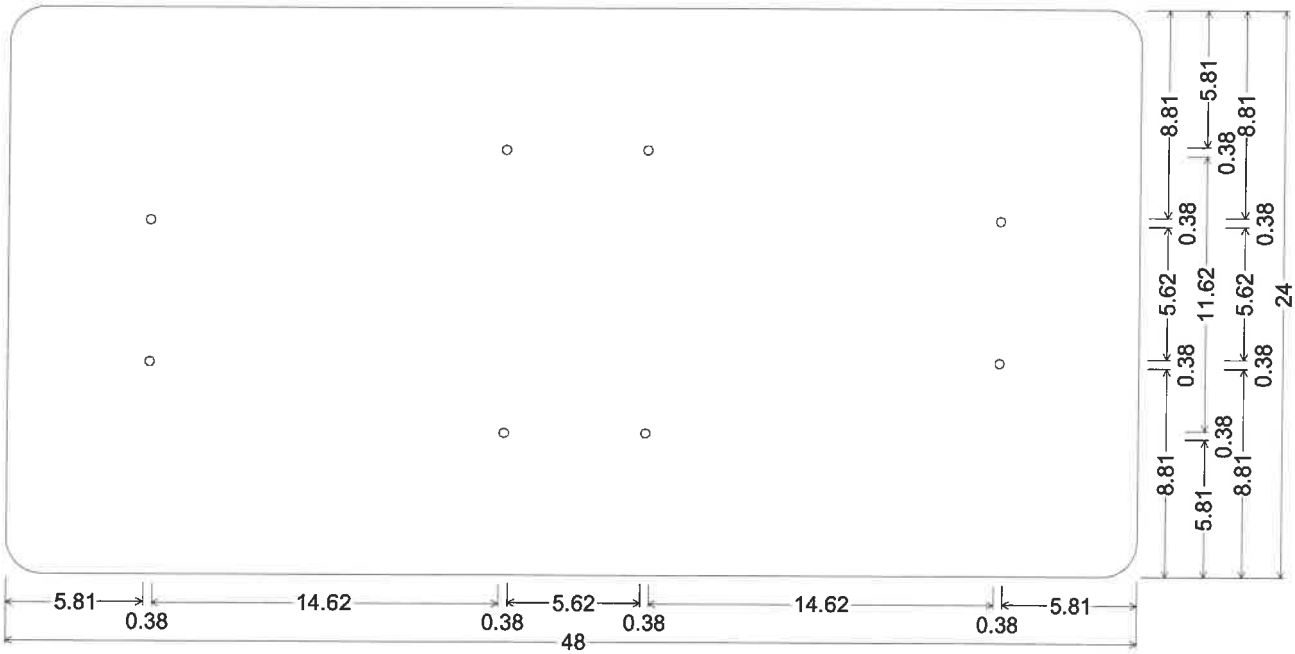

Identifier : DRAWING 29 24X48;  
 1.50" Radius, No border, White on None;  
 Table of widths and spaces.

5.81	○	0.38	14.62	○	0.38	5.62	○	0.38	14.62	○	0.38	5.81
5.81	○	0.38	14.62	○	0.38	5.62	○	0.38	14.62	○	0.38	5.81

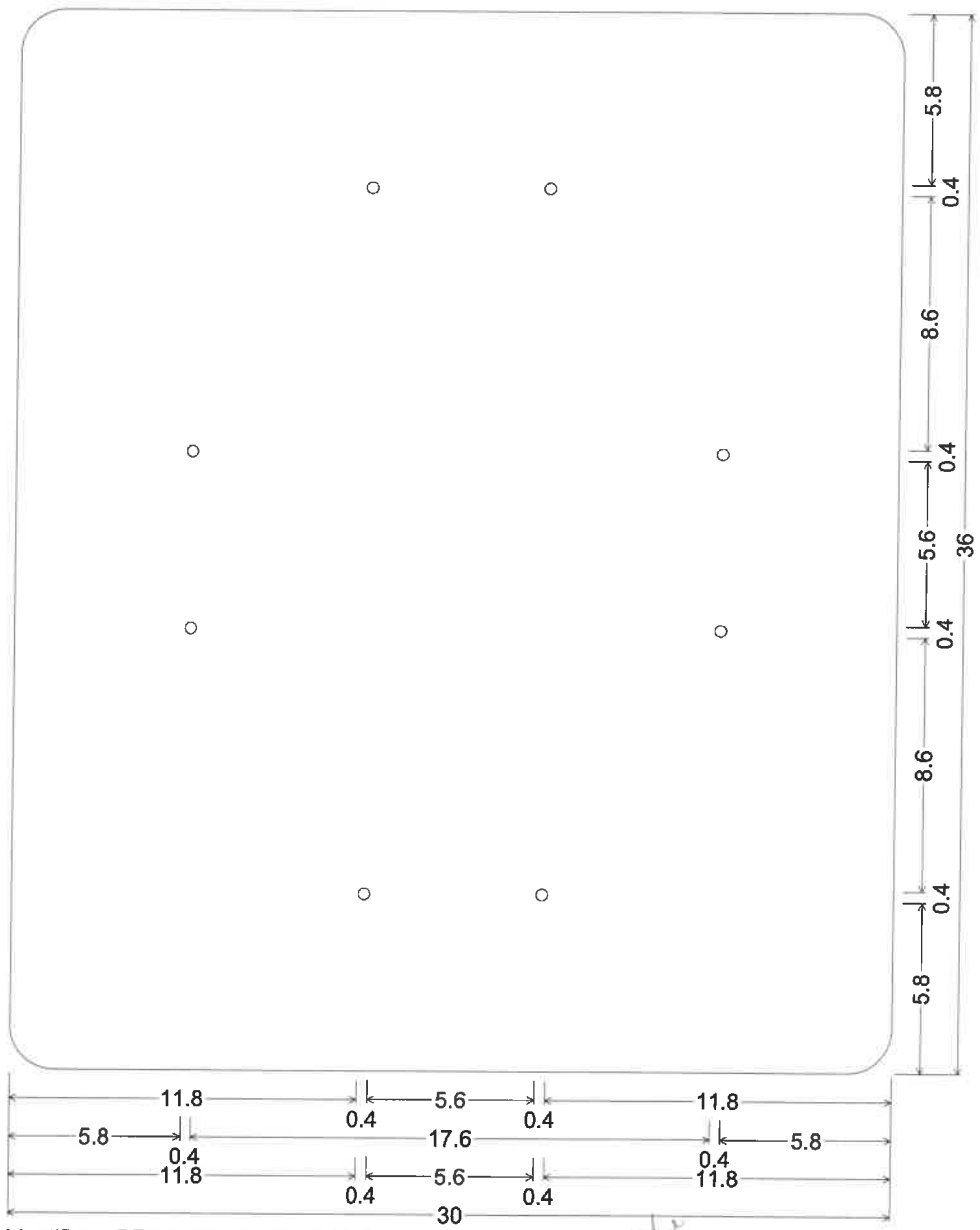

Identifier : DRAWING 30 36X30;  
 1.5" Radius, No border, White on None;  
 Table of widths and spaces.

*rectangle*

11.8	○	0.4	5.6	○	0.4	11.8
5.8	○	0.4	17.6	○	0.4	5.8
5.8	○	0.4	17.6	○	0.4	5.8
11.8	○	0.4	5.6	○	0.4	11.8

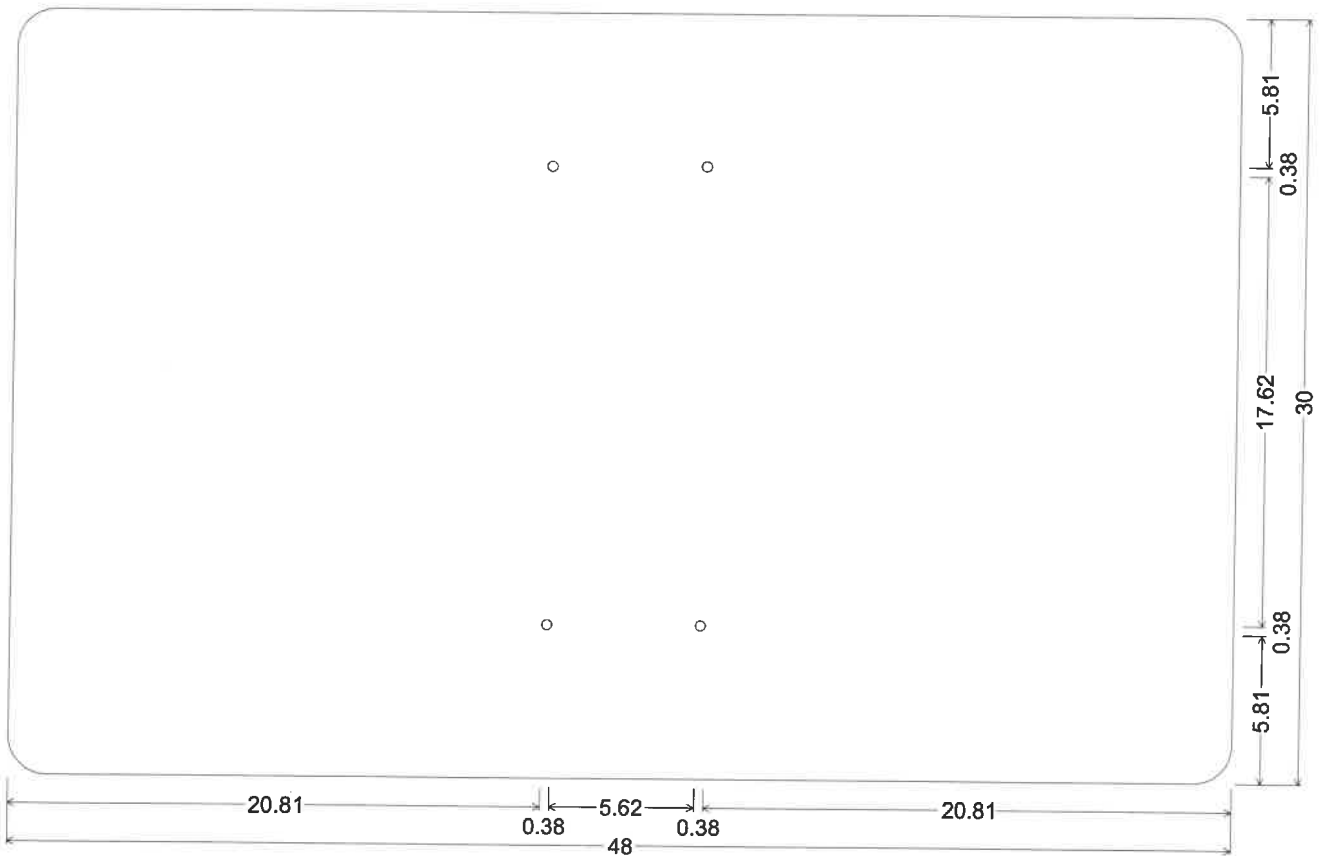

Identifier : DRAWING 31 30X48;  
 1.50" Radius, No border, White on None;  
 Table of widths and spaces.

*rectangle*

20.81	○	0.38	5.62	○	0.38	20.81
20.81	○	0.38	5.62	○	0.38	20.81

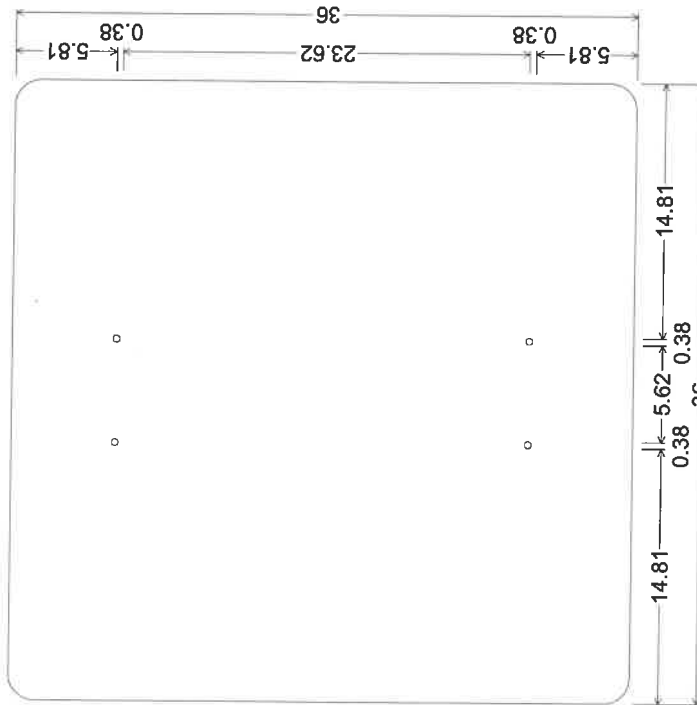

Identifier : DRAWING 32 36X36: ~~—~~ Square  
 1.50" Radius, No border, White on None;  
 Table of widths and spaces.

14.81	0.38	5.62	0.38	14.81
14.81	0.38	5.62	0.38	14.81

Note!

Both holes in the  
 Drawing 329 & 326  
 will be made in the blank

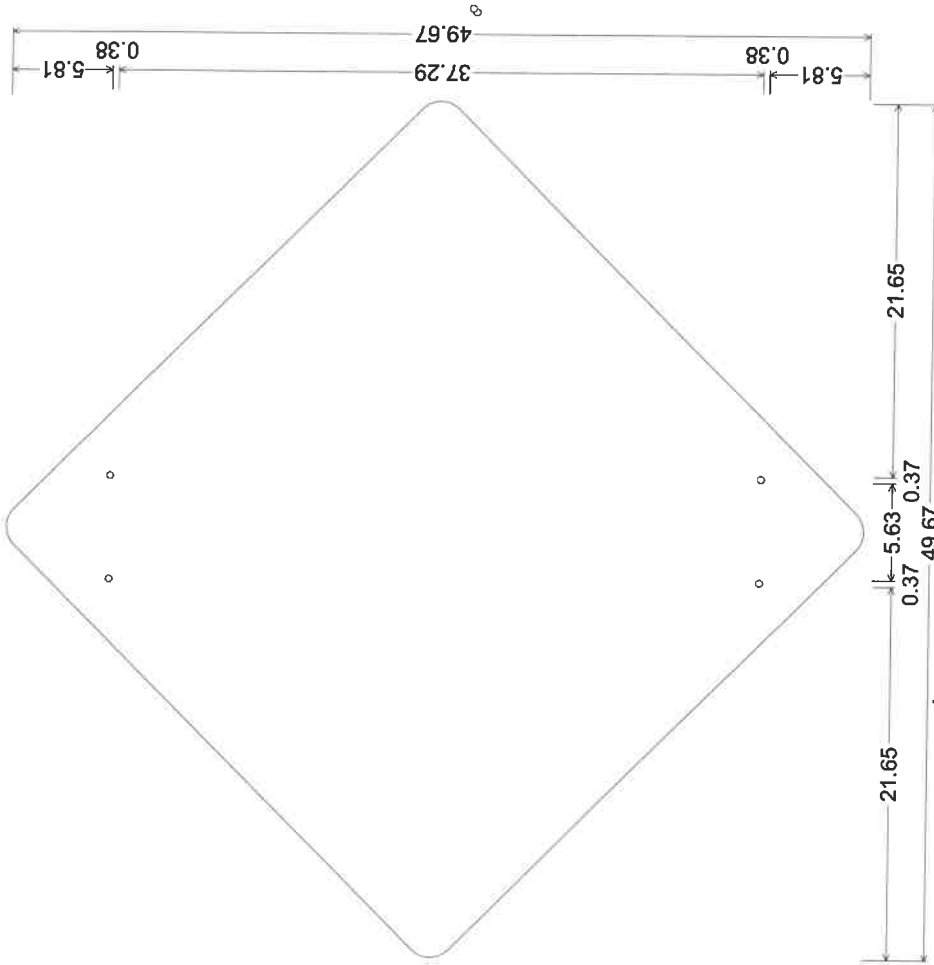

Identifier : DRAWING 32 36X36 DIA;  
 36.00" across sides 1.50" Radius, No border, None;  
 Table of widths and spaces.

21.65	0.37	5.63	0.37	21.65
21.65	0.37	5.63	0.37	21.65

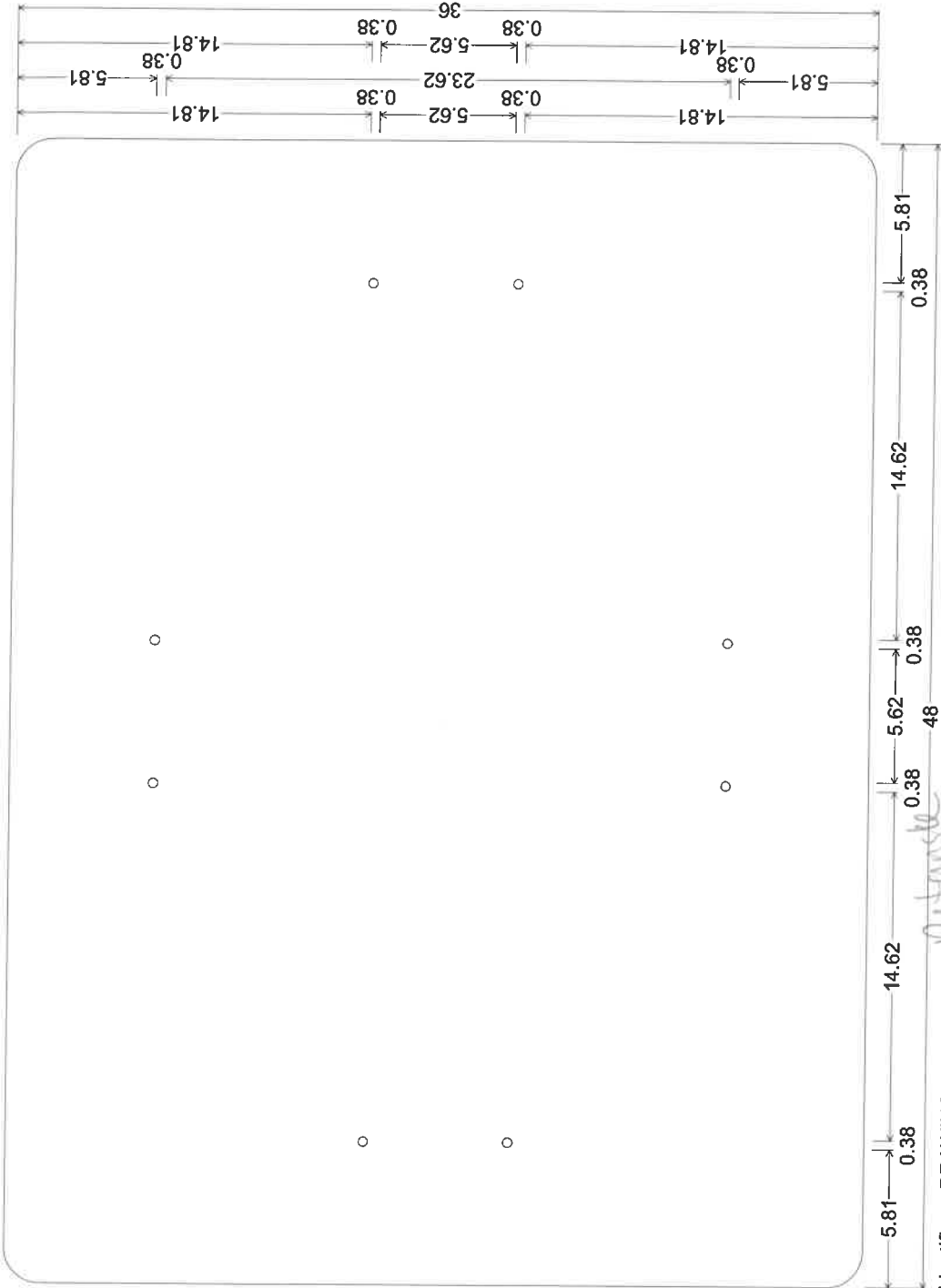

Identifier : DRAWING 33 36X48; *Peterson*

1.50" Radius, No border, White on None;

Table of widths and spaces.

○	○	○	○	○	○	○	○
5.81	0.38	14.62	0.38	5.62	0.38	14.62	0.38
5.81	0.38	14.62	0.38	5.62	0.38	14.62	0.38
5.81	0.38	14.62	0.38	5.62	0.38	14.62	0.38
5.81	0.38	14.62	0.38	5.62	0.38	14.62	0.38

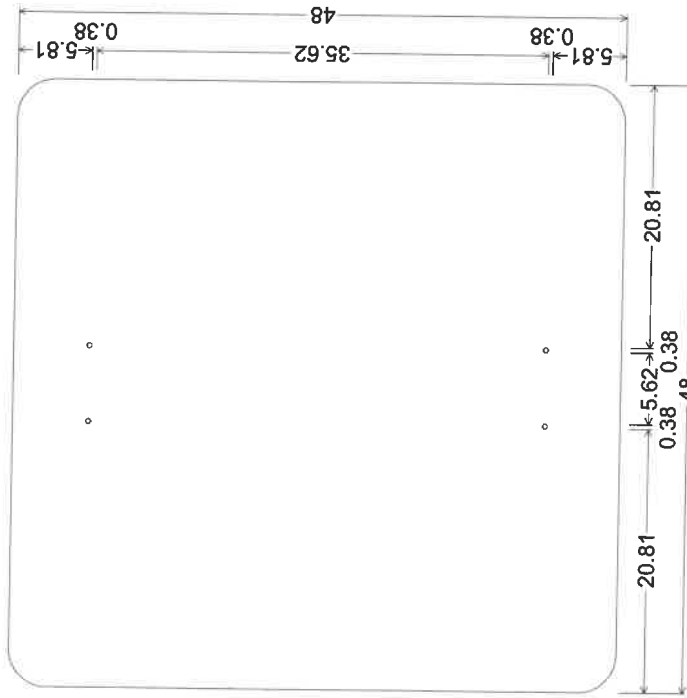

Identifier : DRAWING 34 48X48: ~~Square~~ **Square**  
 3.00" Radius, No border, White on None

Table of widths and spaces.

○	20.81	0.38	5.62	0.38	20.81
○	20.81	0.38	5.62	0.38	20.81

Note!

Both holes in  
 the drawing 3448 346  
 will be made in this  
 blank.

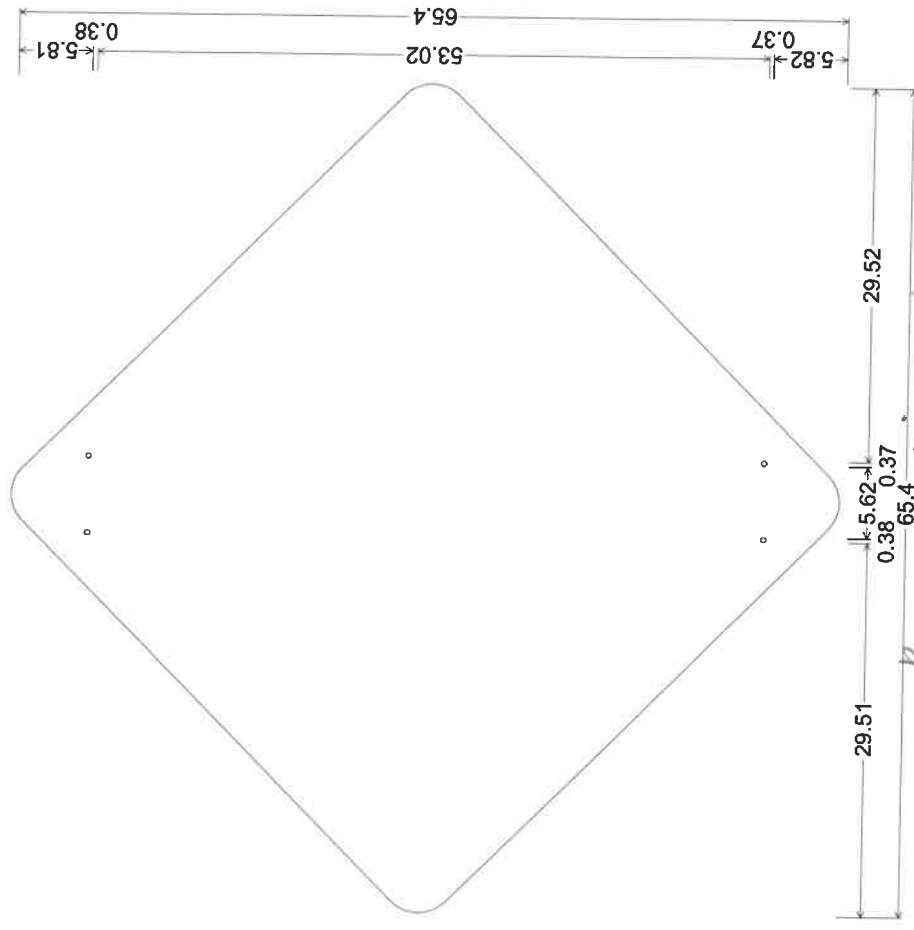

Identifier : DRAWING 34 48X48 SQUARE: ~~Diamond~~ **Diamond**  
 48.00" across sides 3.00" Radius, No border, None;

Table of widths and spaces.

○	29.51	0.38	5.62	0.37	29.52
○	29.51	0.38	5.62	0.37	29.52

X

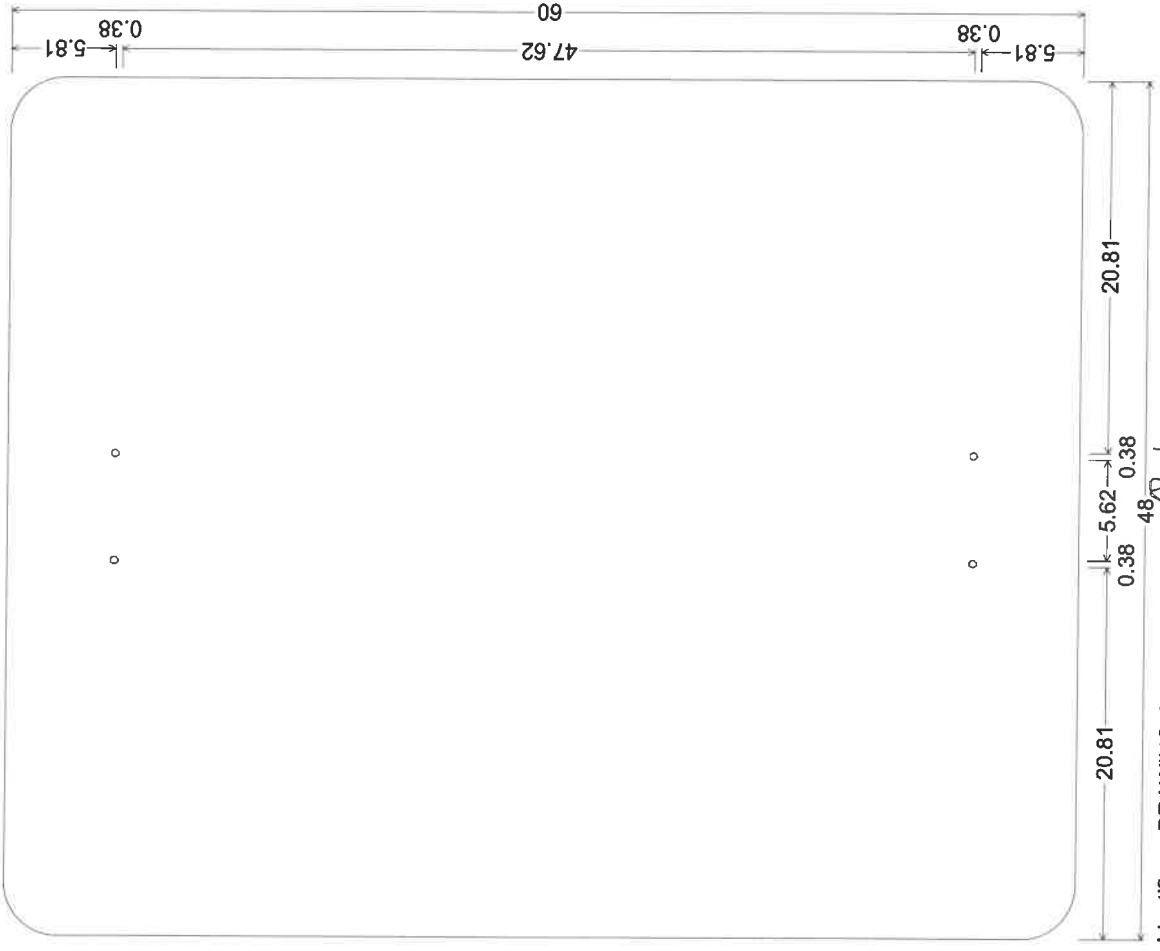

*Balansu*

Identifier : DRAWING 35 48X60,  
 3.00" Radius, No border, White on None;  
 Table of widths and spaces.

○	○	○	○
20.81	0.38	5.62	0.38
20.81	0.38	5.62	0.38
20.81	0.38	5.62	0.38



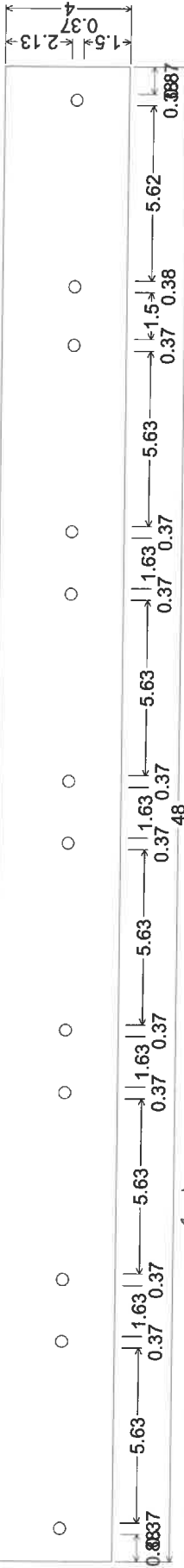

Identifier : DRAWING 36 4X48: *Retangle*

No border, White on None;  
Table of widths and spaces.

○	○	○	○	○	○	○	○	○	○	○	○	○								
0.88	0.37	5.63	0.37	1.63	0.37	5.63	0.37	1.63	0.37	5.63	0.37	1.63	0.37	5.63	0.37	1.50	0.38	5.62	0.38	0.87

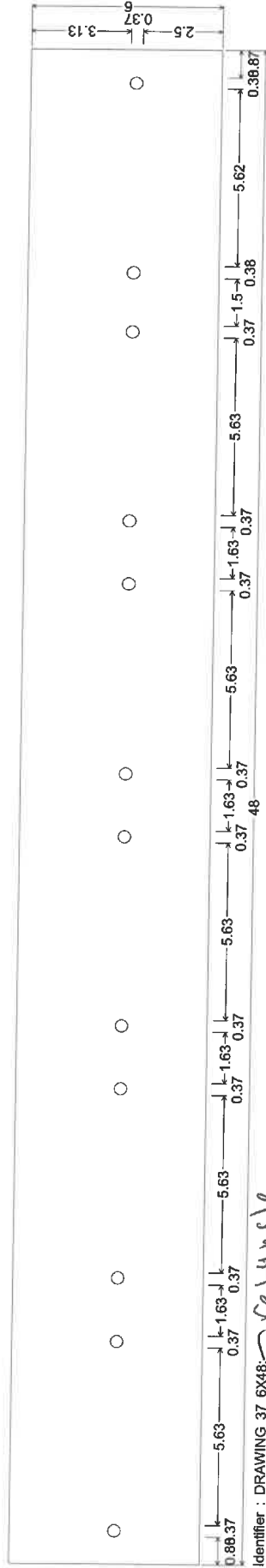

Identifier : DRAWING 37 6X48;  
 No border, White on None;  
 Table of widths and spaces.

0.88	0.37	5.63	0.37	1.63	0.37	5.63	0.37	1.63	0.37	5.63	0.37	1.63	0.37	5.63	0.37	1.50	0.38	5.62	0.38	0.87
------	------	------	------	------	------	------	------	------	------	------	------	------	------	------	------	------	------	------	------	------

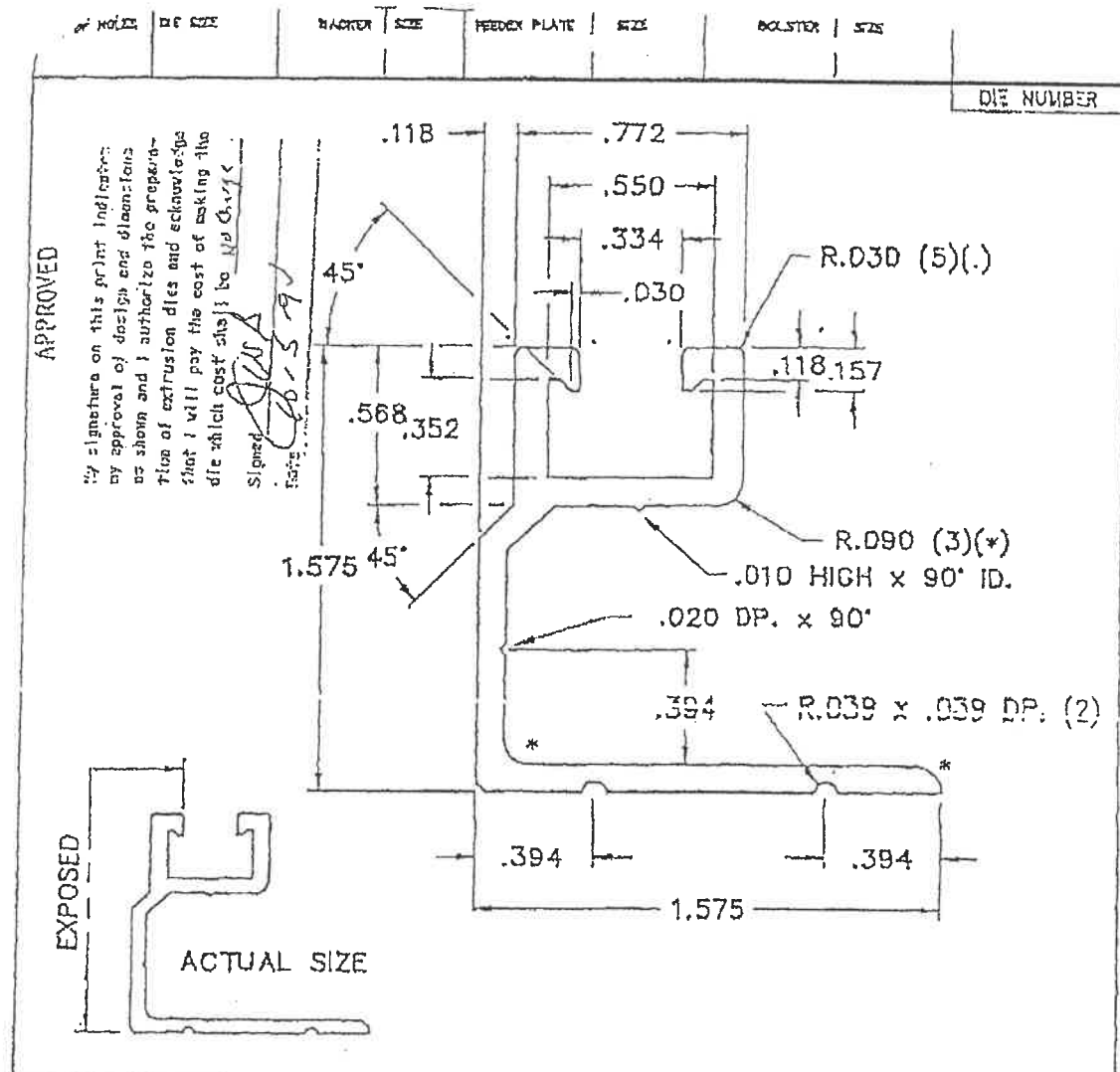

STANDARD COMMERCIAL TOLERANCES FOR EXTRUDED PRODUCTS APPLY UNLESS OTHERWISE SPECIFIED DO NOT SCALE DRAWING			
NO. REVISIONS		DATE	CUSTOMER FLORIDA D.O.T.
UNSPECIFIED WALL THICKNESS .098			APPLICATION CORNER ANGLE
EST. AREA .451	EST. H/F 1.100	EST. PARAMETERFACTOR 9.136	DRAWN BY DATE WRG 10/24/82
CAVITY SIZE	MAX. RATIO	FILE NUMBER 22-A5024	SCALE 2:1
		CIRCLE SIZE 2-3	ALLOY 6061-T6
			CUSTOMER # HPN-054

DRAWING #38

Rev 7/7/10

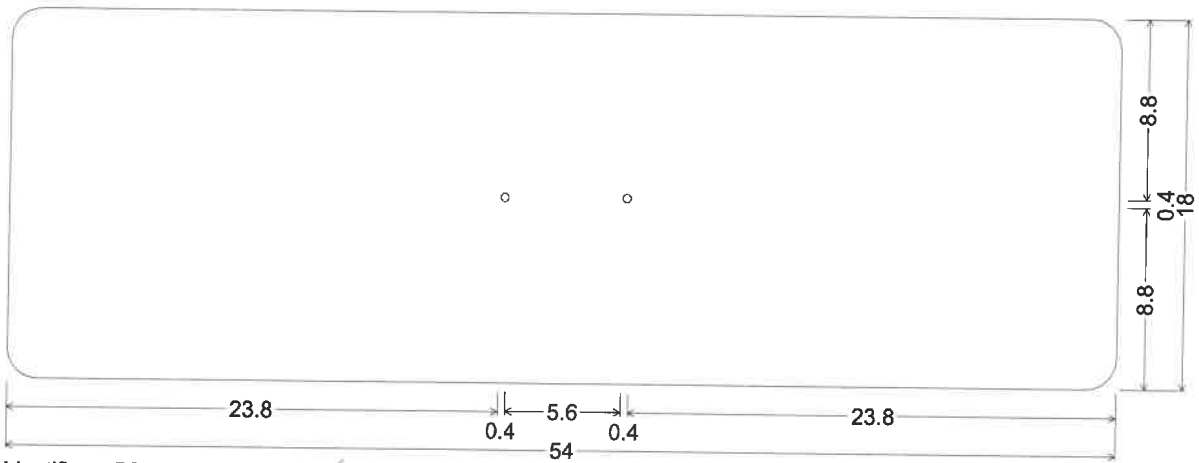

Identifier : DRAWING 40 18X54;  
 1.5" Radius, No border, White on None;  
 Table of widths and spaces.

*Rectangle*

23.8	○	0.4	5.6	○	0.4	23.8
------	---	-----	-----	---	-----	------

|

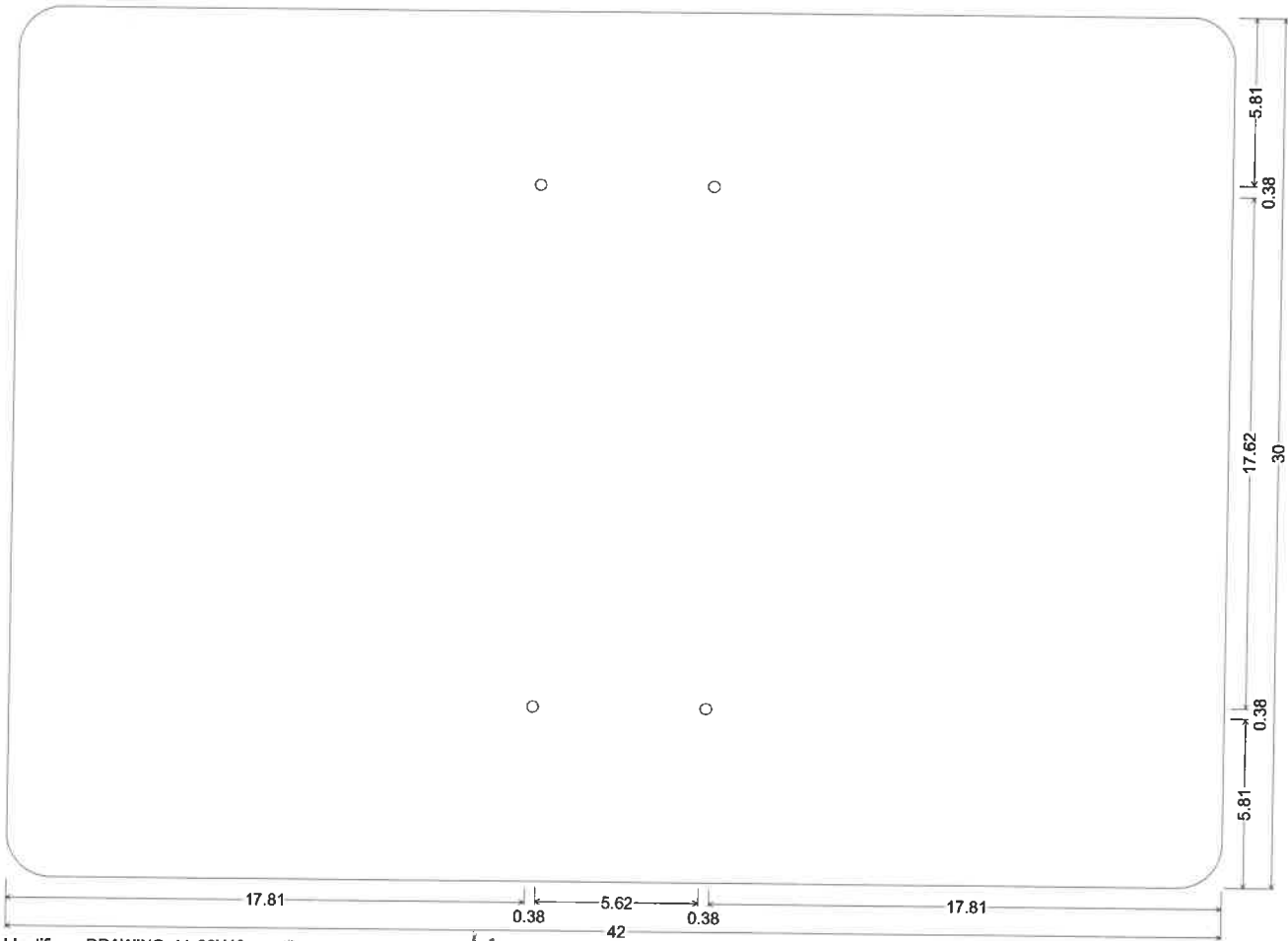

Identifier : DRAWING 41 30X42;  
 1.50" Radius, No border, White on None;  
 Table of widths and spaces.

*rectangle*

○	○			
17.81	0.38	5.62	0.38	17.81
○	○			
17.81	0.38	5.62	0.38	17.81

## BID CHECKLIST

(DOES NOT NEED TO BE RETURNED WITH YOUR BID)

This Checklist is provided as a guideline, only, to assist bidders in the preparation of their bid response. Included are some important matters that the bidder should check. This checklist is just a guideline, and is not intended to include all matters required by the ITB. Bidders are responsible to read and comply with the ITB in its entirety.

Check off each the following:

- \_\_\_ 1. The "Bid Sheet" has been filled out completely, signed, and enclosed in the bid response.
- \_\_\_ 2. The Federal Employers Identification Number or Social Security Number has been entered in the space provided.
- \_\_\_ 3. "Drug-Free Workplace Program Certification" form has been read, signed, and enclosed in the bid response, if applicable.
- \_\_\_ 4. "Scrutinized Companies Lists" certification form has been read, signed, and enclosed in the bid response, if applicable (bids of \$1 million or more).
- \_\_\_ 5. The Technical Specifications section has been thoroughly reviewed for compliance to the bid requirements.
- \_\_\_ 6. The prices bid have been reviewed for accuracy and all price corrections have been initialed in ink.
- \_\_\_ 7. The "Certification of Recycled Content" form, (if applicable) has been filled out completely and enclosed in the bid response.
- \_\_\_ 8. The "Ordering Instructions" form has been completed and enclosed in the bid response.
- \_\_\_ 9. The [www.myflorida.com](http://www.myflorida.com) website has been checked and any Addendums posted have been completed, signed, and included in the bid response.
- \_\_\_ 10. The bid response must be received, at the location specified, **on or before** the Bid Due Date and Time designated in the ITB.
- \_\_\_ 11. On the Lower Left Hand Corner of the Envelope transmitting your bid response, write in the following information:

Bid No.: ITB-DOT-17/18-9106-KW

Title: ALUMINUM MATERIALS

Opening Date & Time: See "TIMELINE" in INTRODUCTION SECTION